

IMPORTANT, RETAIN FOR FUTURE REFERENCE PLEASE READ CAREFULLY



Boori Urbane Products

AUSTRALIA
18-20 Charles Street
St.Marys Sydney NSW
2760 Australia
Ph: 61 2 9833 3769 Fax: 61 2 9673 4240

Boori (UK) Ltd
Unit 8, Transigo,
Gables Way, Kennet Park,
Thatcham, Berkshire,
RG19 4ZA
Ph: (44) 016 3529 5670 Fax: (44) 016 3587 7552

Boori Urbane Hamilton cot 3 in 1

Cot Hardware and parts list

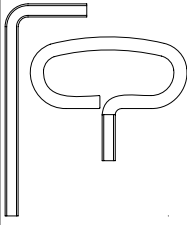
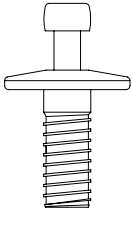
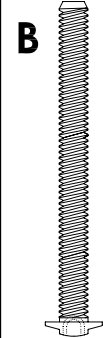
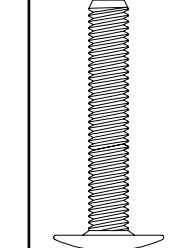
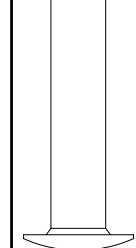
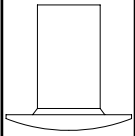
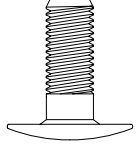
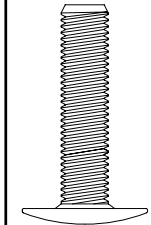
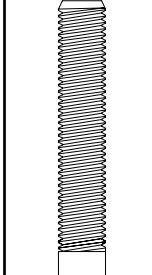
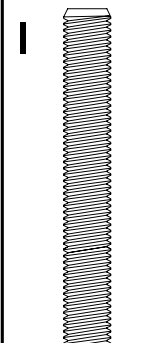
2 x Allen Keys	4 x Drop side glide pins	8 x 45mm T-Rail bolts	4 x 30mm Connecting bolts	4 x Capping nuts	4 x Capping nuts	4 x 18mm Connecting bolts	4 x 28mm Connecting bolts	4 x 54mm Connecting bolts	4 x 70mm Connecting bolts
	A 	B 	C 	D 	E 	F 	G 	H 	I 

Actual size Actual size

Actual size

Actual size

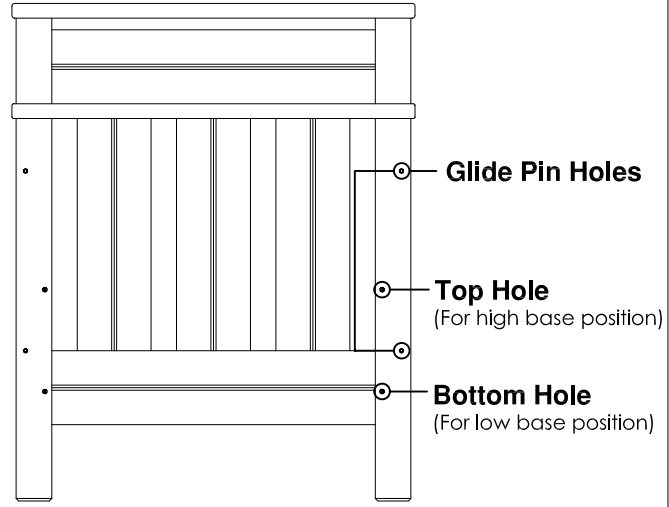
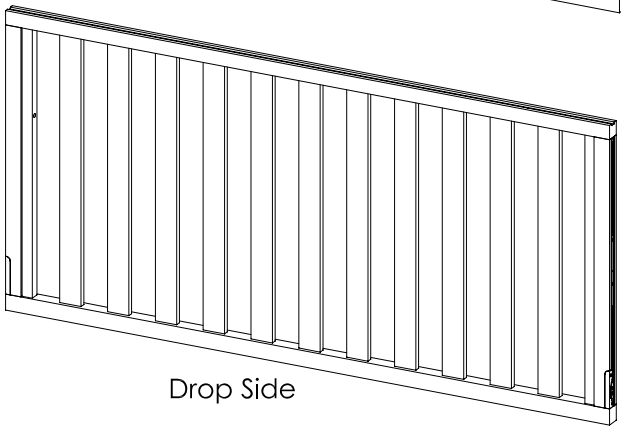
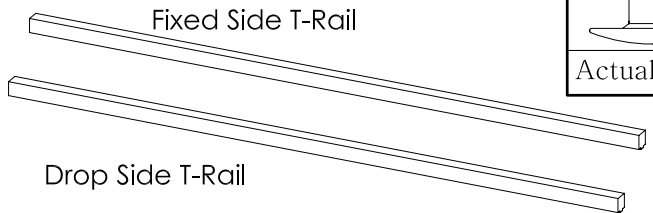
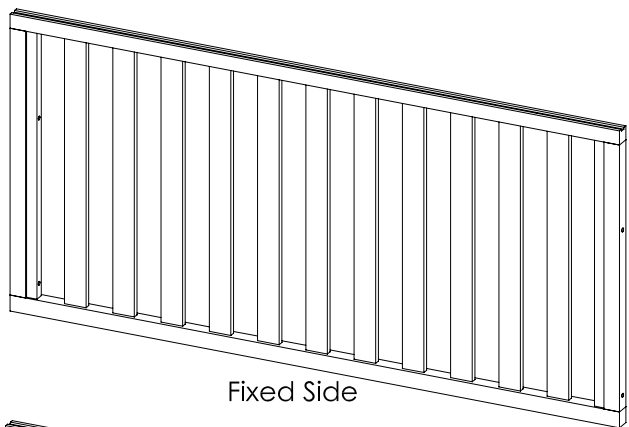

2 x End Panels (Identical)

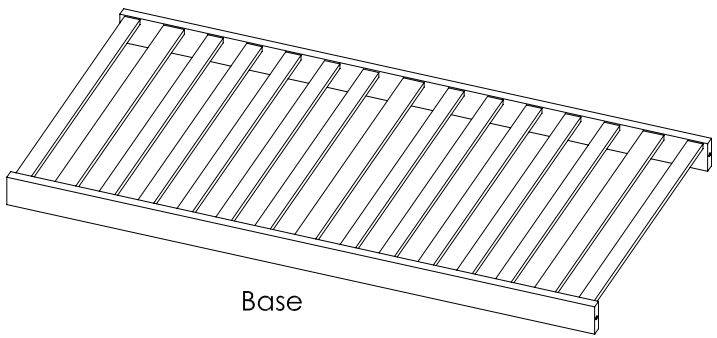

Hamilton cot 3 in 1 assembly instructions

Stage 1: Attaching the side panels

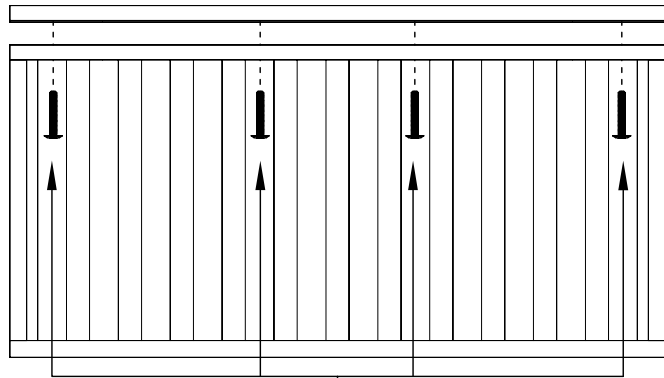

Push side panels header onto the side panels and then screw 4 X B 45mm T-Rail bolts using a philips head screwdriver (not supplied).

Stage 2: Attaching the fixed side

A: Connect fixed side panel to the two end panels with the 4 X I (70mm) connecting bolts provided.
(Do not tighten at this stage).

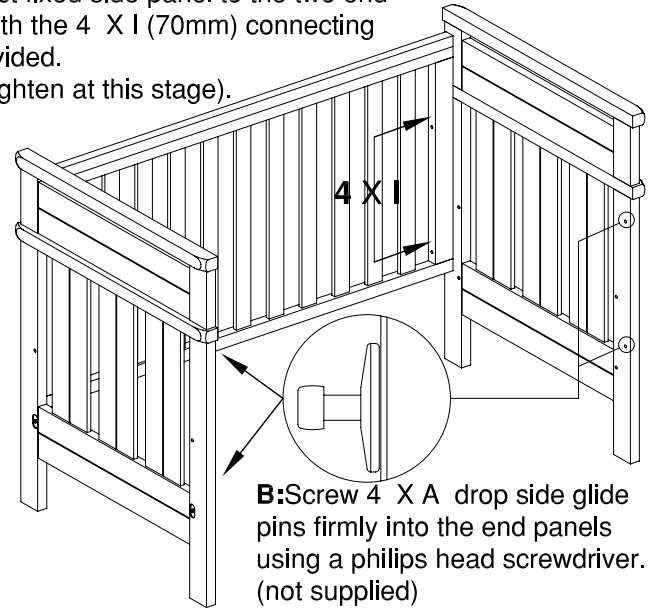

B: Screw 4 X A drop side glide pins firmly into the end panels using a philips head screwdriver (not supplied).

Stage 3: Attaching the base

Connect mattress base to the two end panels with the 4 X I (70mm) connecting bolts provided. (DO NOT tighten at this stage).

Top holes for the newborn position.

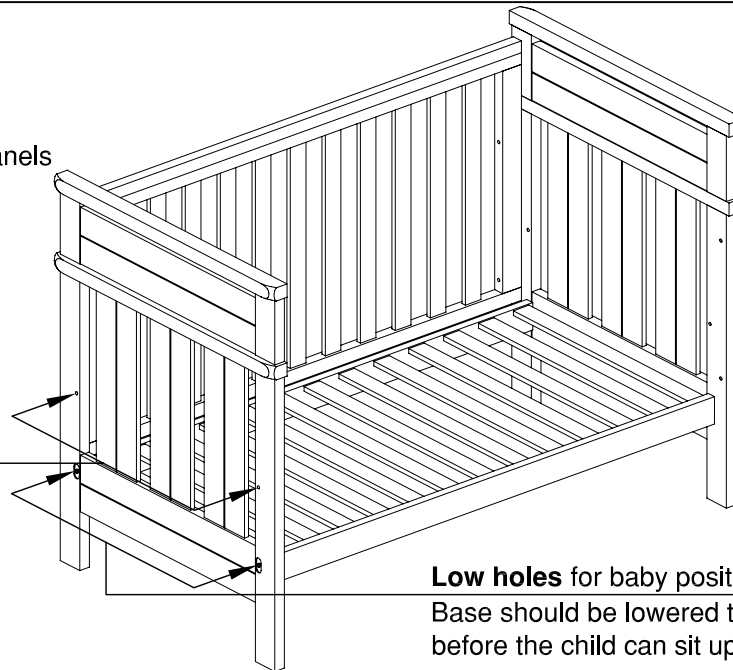

Low holes for baby position.

Base should be lowered to this position before the child can sit up.

Stage 4: Attaching the drop side

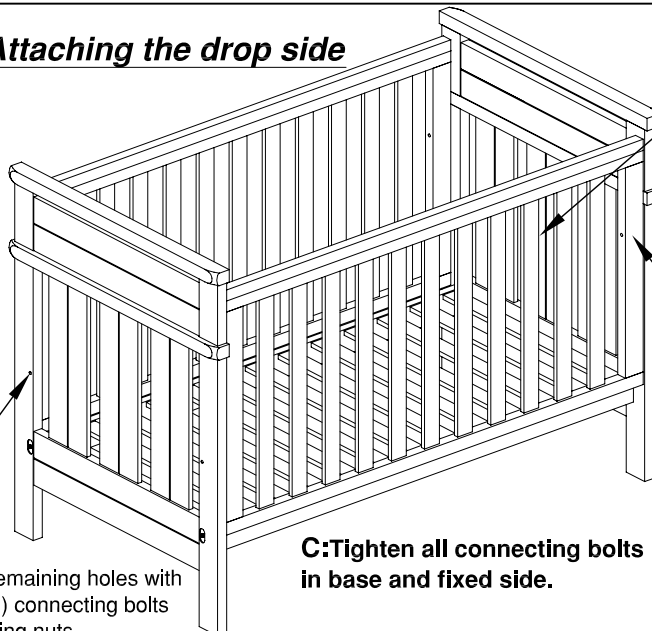

Then cover remaining holes with 4 X G (28mm) connecting bolts & 4 X E capping nuts.

C: Tighten all connecting bolts in base and fixed side.

Ensure that correct side is facing out

A: Push end panels outward to allow space for the assembly of the drop side panel. Allow glide pins of one end panel to attach into the runner on drop side first, then allow the pins on the other side to slide into runner and pull both end panels inward.

B: Fully screw in blocking bolts on both end bars of drop side panel.

TO LOWER THE DROP SIDE PANEL pull the drop side up to the highest position. Hold it in that position while using your leg to push (at the centre bottom bar) inward. Then allow the drop side panel to slide down. To raise the drop side panel, pull the drop side panel up from the centre of top bar until it clicks into the locking position.

Hamilton cot 3 in 1 assembly instructions

Stage 5: Lowering the base height

Remove 4 X G bolts & 4 X E capping nuts from lower holes in end panels.

Loosen 4 X I bolts in fixed side. Then remove 4 X H bolts in base and lower base to baby position. Screw 4 X H bolts in to base.

Screw 4 X G bolts & 4 X E capping nuts into end panels.

Tighten all remaining bolts in base and fixed side.

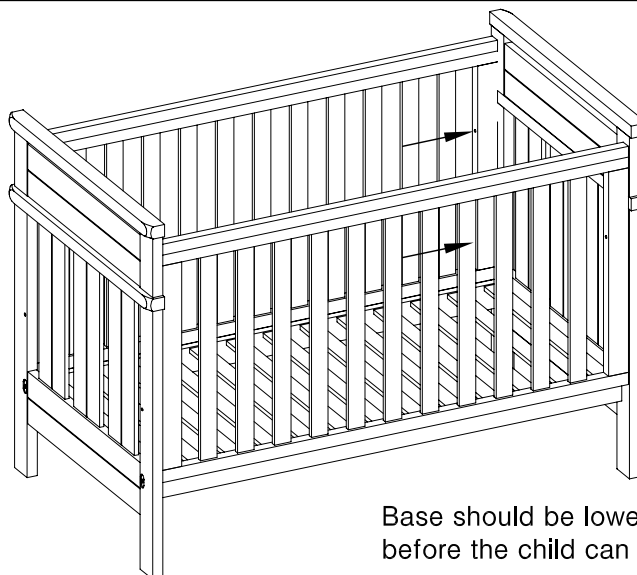

Base should be lowered to this position before the child can sit up.

Stage 6: Converting to a Junior Bed

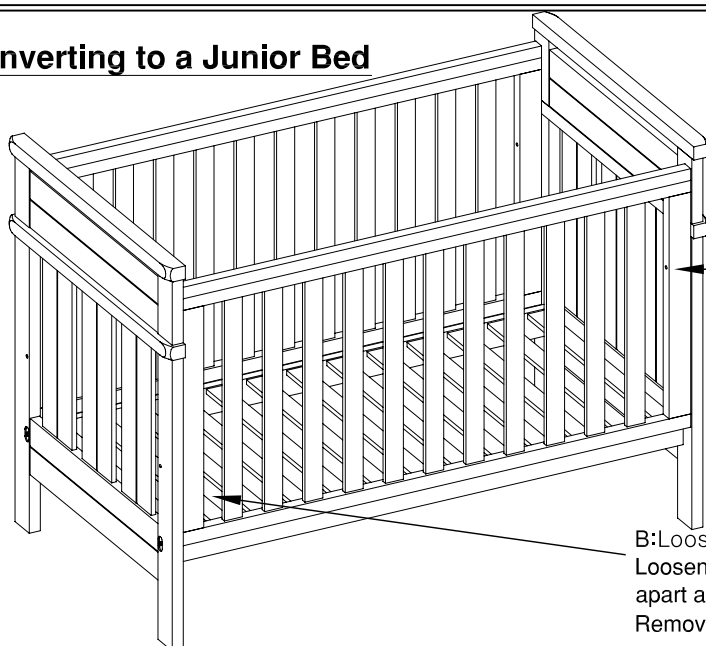

A: Loosen 2 X drop side blocking bolts.

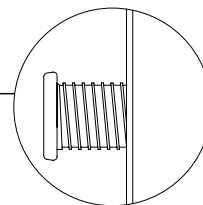

B: Loosen 4 X I bolts in fixed side. Loosen 4 X H bolts in base, then pull end panels apart and remove the drop side from glide pins. Remove fixed side panel.

Stage 7: Scout Junior Bed

Remove 4 X A drop side glide pins from end panels. If uncovered, cover remaining holes with 4 X G bolts & 4 X E capping nuts in end panels.

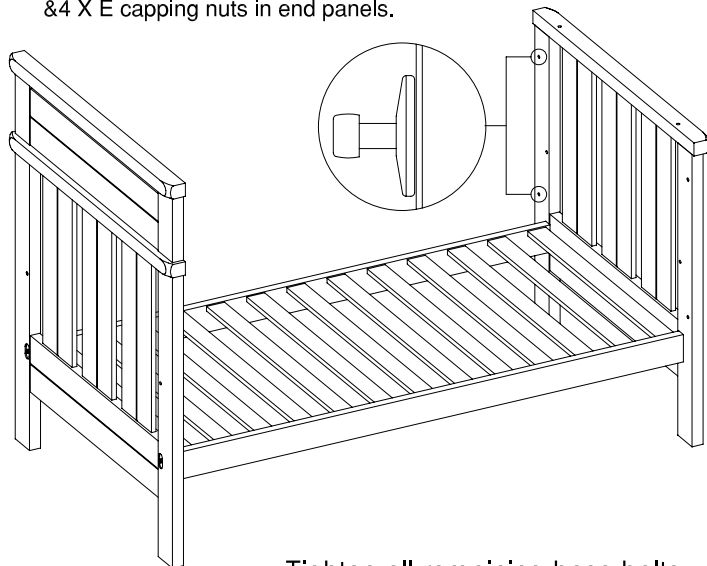

Tighten all remaining base bolts.

Stage 8: Converting to Sofa

Remove the drop side (see cot assembly instructions). Remove the 4 drop side glide pins. Re-attach the fixed side.

If uncovered, cover remaining holes with 4 X F bolts, 4 X G bolts & 4 X E capping nuts in end panels, the top holes with 4 X C bolts & 4 X D capping nuts.

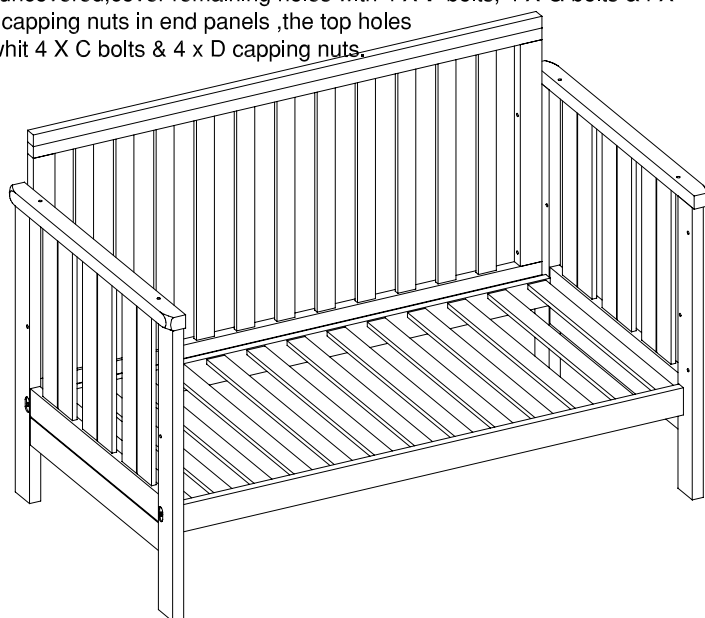



Boori Urbane Cot/Junior Bed assembly instructions

FOR AUSTRALIA AND NEW ZEALAND

(AS/NZS 2172:2003)

RECOMMENDED MATTRESS SIZE 1320mm X 700mm X 120mm

This cot has been manufactured for use with a mattress which measures 700mm wide by 1320mm long and a maximum thickness of 120mm. The width and length are specified because it is important that the gaps between the mattress sides and ends of the cot will not exceed 40mm. This is to minimise the risk of a child's limb becoming caught in the gap. The thickness of the mattress has been specified to ensure that the depth of the cot is greater than 500mm with the mattress base in the lower position to minimise the risk of a child climbing or falling out of the cot.

Warning:

- * **TO ENSURE THE SAFETY OF YOUR COT, REGULARLY CHECK ALL THE CONNECTING BOLTS AND GLIDE PINS MAKING SURE THEY ARE TIGHT.**
- * **TO PREVENT FALLS OR SUFFOCATION THE MAXIMUM MATTRESS THICKNESS SHOULD NOT EXCEED 120MM .**
- * **TO PREVENT FALLS, THE MATTRESS BASE OF THIS COT SHOULD BE ADJUSTED TO THE LOWEST POSITION BEFORE THE CHILD CAN SIT UP.**
- * Follow the manufacturer's assembly instructions in detail to ensure the safety features of the cot are not compromised.
- * Ensure the cot is placed at a reasonable distance from curtains, blinds, heaters and power points.
- * Keep cot free of any toys, cushions etc that could be used as a foothold or present a danger of suffocation or strangulation.
- * Keep medication, String, elastic or small items such as money out of reach from any position in the cot.

FOR THE UK

(EN716-2008)

RECOMMENDED MATTRESS SIZE 1320mm X 700mm x 120mm

If you leave the child unattended in the cot, always make sure that the dropside is in the highest position.

This cot has been manufactured for use with a mattress which measures 700mm wide by 1320mm long and a maximum thickness of 120mm. The width and length shall be such that the gap between the mattress and the sides and ends does not exceed 30mm. The thickness of the mattress has been specified to ensure that the depth of the cot is greater than 500mm with the mattress base in the lower position and 200mm with the mattress in the highest position to minimise the risk of a child climbing or falling out of the cot.

Warning:

- * **TO ENSURE THE SAFETY OF YOUR COT , REGULARLY CHECK ALL THE CONNECTING BOLTS AND GLIDE PINS MAKING SURE THEY ARE TIGHT, CARE SHOULD BE TAKEN THAT NO SCREWS ARE LOOSE BECAUSE A CHILD COULD TRAP PARTS OF THE BODY OR CLOTHING (EG. Strings, necklaces, ribbons for babies dummies), WHICH WOULD POSE A RISK OF STRANGULATION.**
- * **TO PREVENT FALLS, THE MAXIMUM MATTRESS THICKNESS SHOULD NOT EXCEED 120MM.**
- * **THE LOWEST POSITION IS THE SAFEST AND THAT THE BASE SHOULD ALWAYS BE USED IN THAT POSITION AS SOON AS THE BABY IS OLD ENOUGH TO SIT UP.**
- * **TO PREVENT INJURY FROM FALLS THAT WHEN THE CHILD IS ABLE TO CLIMB OUT OF THE COT, THE COT SHALL NO LONGER BE USED FOR THAT CHILD.**
- * Be aware of the risk of open fire and other sources of strong heat, such as electric bar fires, gas fires, etc.in the near vicinity of the cot.
- * Do not use the cot if any part is broken, torn or missing and use only spare parts approved by the manufacturer.
- * Do not leave anything in the cot or place the cot close to another product, which could provide a foothold or present a danger of suffocation or strangulation, e.g.strings, blind/curtain cords, etc.
- * Do not use more than one mattress in the cot.

Maintenance of your Boori Urbane Cot

- * **TO ENSURE THE SAFETY OF YOUR COT, REGULARLY CHECK ALL THE CONNECTING BOLTS AND GLIDE PINS MAKING SURE THEY ARE TIGHT, CARE SHOULD BE TAKEN THAT NO SCREWS ARE LOOSE**
- * **GLIDE PINS AND BOLTS SHOULD BE TIGHTENED EVERY FOUR TO SIX MONTHS TO ENSURE COT REMAINS STABLE**
- * **TO CLEAN YOUR COT USE A SOFT CLOTH DAMPENED WITH WATER**
- * **DO NOT USE STRONG HOUSEHOLD CLEANERS**
- * **AVOID CONTACT WITH SHARP OBJECTS**
- * **WHEN MOVING YOUR COT DO NOT DRAG, ALWAYS LIFT AND PLACE IN POSITION**