

Boori

Silla



Compact Cot

塞拉婴儿床

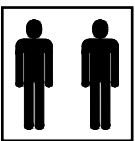

**IMPORTANT:
PLEASE READ THE INSTRUCTIONS CAREFULLY
AND KEEP FOR FUTURE REFERENCE**

重要：请仔细阅读此说明书，并妥善保管以便日后参考。

B-SICCO

Boori Australia Pty Ltd
 18-20 Charles Street
 St. Marys Sydney NSW
 2760 Australia
 Tel: + 61 2 9833 3769
 Fax: + 61 2 9673 4240
 www.boori.com.au

Boori (Europe) Ltd
 Unit 1 Riverside House,
 Mill Lane, Newbury,
 Berkshire, RG 14 5QS UK
 Tel: + 44 016 3529 5670
 Fax: + 44 016 3587 7552
 www.boori.co.uk

Halim & Boori Company
 10F. Halim INT'L B/D, #1674-4,
 Seocho-Dong, Seocho-Gu,
 Seoul, Korea
 Tel: + 82 2598 1470
 Fax: + 82 2583 8885
 E-mail : ted@boori.co.kr
 Postal code: 137-725.

ブーリジャパン株式会社
 〒141-0031
 東京都品川区西五反田
 7-22-17 TOCビル5F
 TEL:03-6420-0024
 EMAIL:info@boori.co.jp
 HP:www.boori.jp







上海微奈莎商贸有限公司
 博瑞儿童用品(上海)有限公司
 上海市青浦区徐泾镇华徐公路577号
 VEG微格创意园A8-10室
 邮编: 201702
 电话: + 86 21 5296 6600
 传真: + 86 21 5296 6636
 网址: www.boori.com.cn

Silla Compact Cot (B-SICCO)

Dimensions (External / 外径): 1258*712*852mm
 产品规格 (Internal / 内径): 1200*654mm

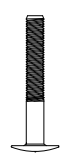
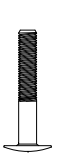
Main Materials: Australia Araucaria
 主要材质: 澳洲南洋杉

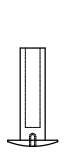
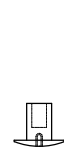
Hardware / 五金单

A x 1	B x 4	C x 16	D x 4	E x 8	F x 8	G x 4	H x 16	I x 2	J x 2
									
	M6*70mm	M6*60mm	M6*47mm	M6*35mm	M6*13mm	M6*45mm	M6*14mm		

Parts List / 部件清单

NOTE: Use only spare parts approved by the manufacturer.
 注意: 仅限使用制造商提供的产品零配件及五金。

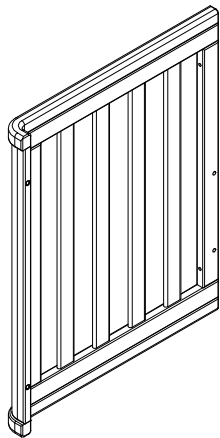

① x2

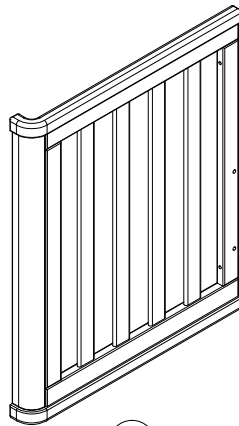

② x2

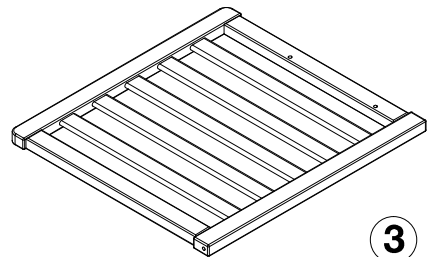

③ x2

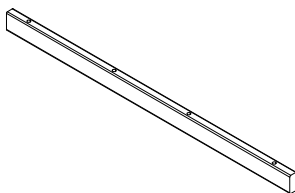

④ x1

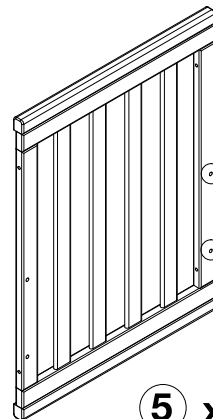

⑤ x2

Top Hole
高孔位

Bottom Hole
低孔位

Assembly / 安装说明

1

Assembling another in the same way.
用相同的方法组装另一个。
Do not tighten the bolts for now.
螺丝暂时不要完全锁紧。

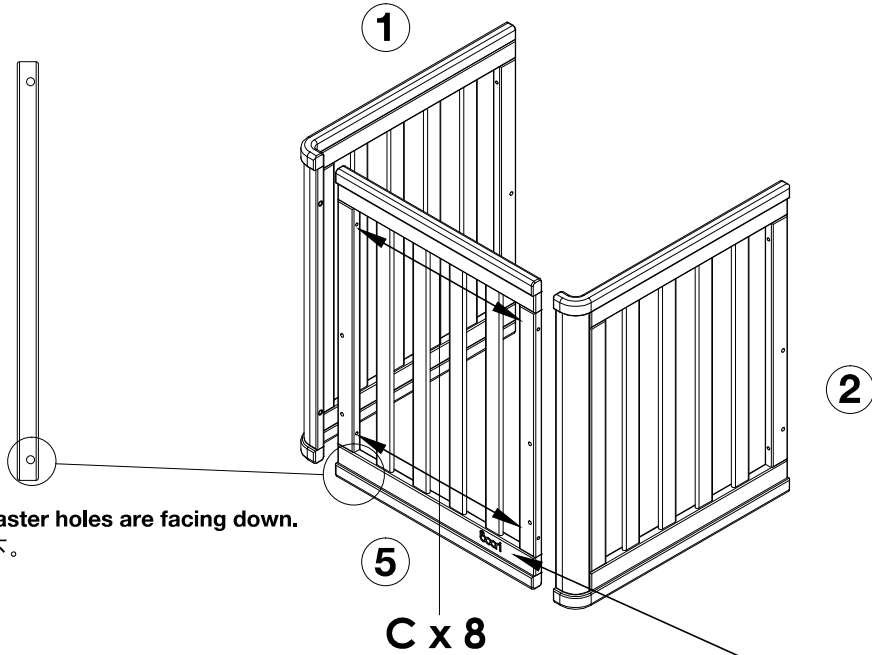

C x 8

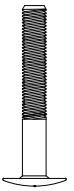

Make sure the caster holes are facing down.
确保脚轮孔边朝下。

The logo should face outside.
logo朝外。

2

Assembling another in the same way.
用相同的方法组装另一个。
Do not tighten the bolts for now.
螺丝暂时不要完全锁紧。

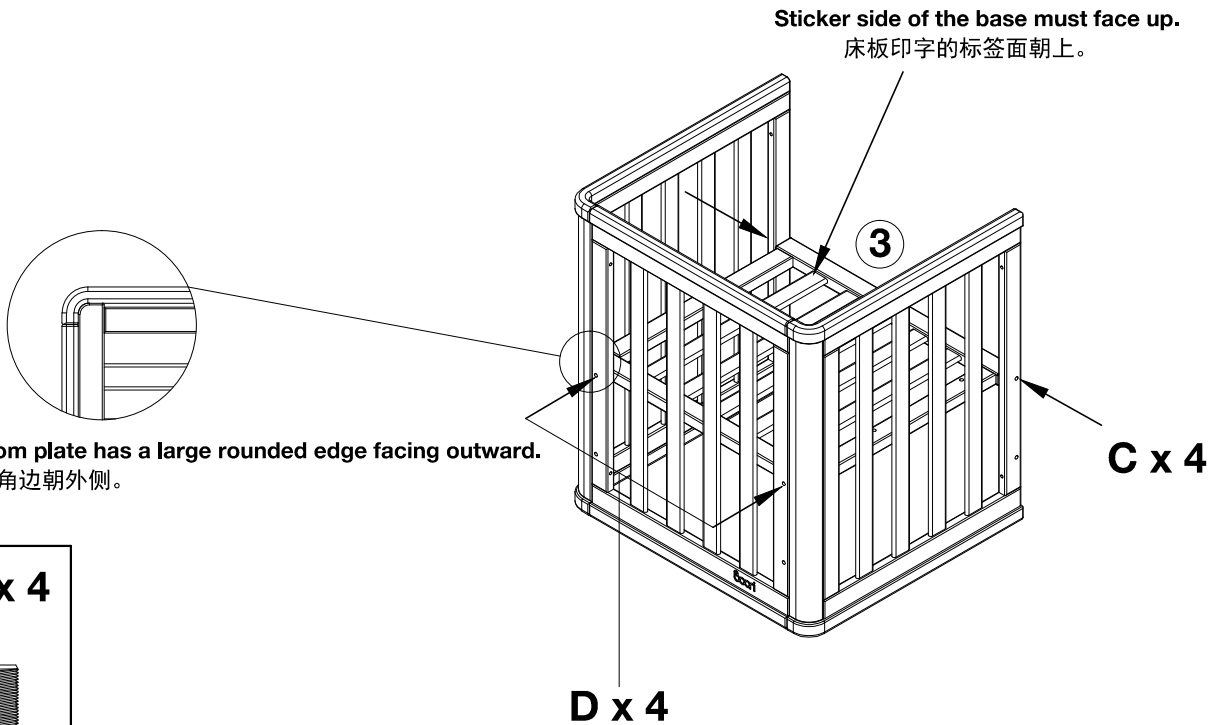

C x 4

D x 4

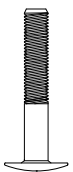
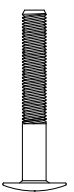

Assembly / 安装说明

3

Tighten all the connecting bolts.
锁紧所有螺丝。

Top Hole high base position(for newborn).
高孔位: 底板放置高位 (新生儿使用)。

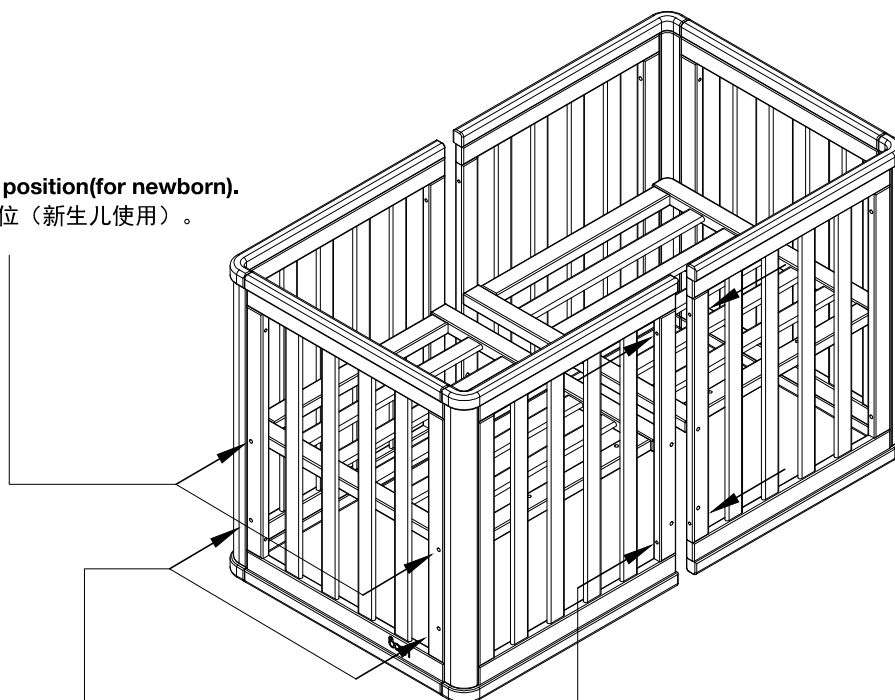

C x 4 G x 4

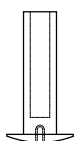
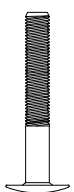

Bottom Hole low base position(for baby).
低孔位: 底板放置低位 (婴幼儿使用位置)。

Base should be lowered to this position
before child is able to sit up.
当婴幼儿能坐起时改到床底板低位。

(C+G) x 4

4

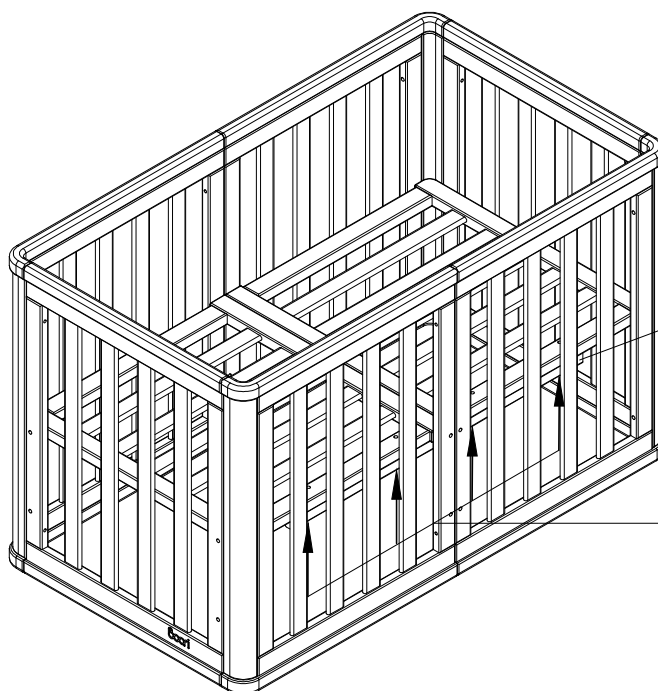

B x 4 H x 4

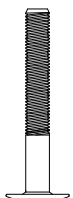

(B+H) x 4

Assembly / 安装说明

5

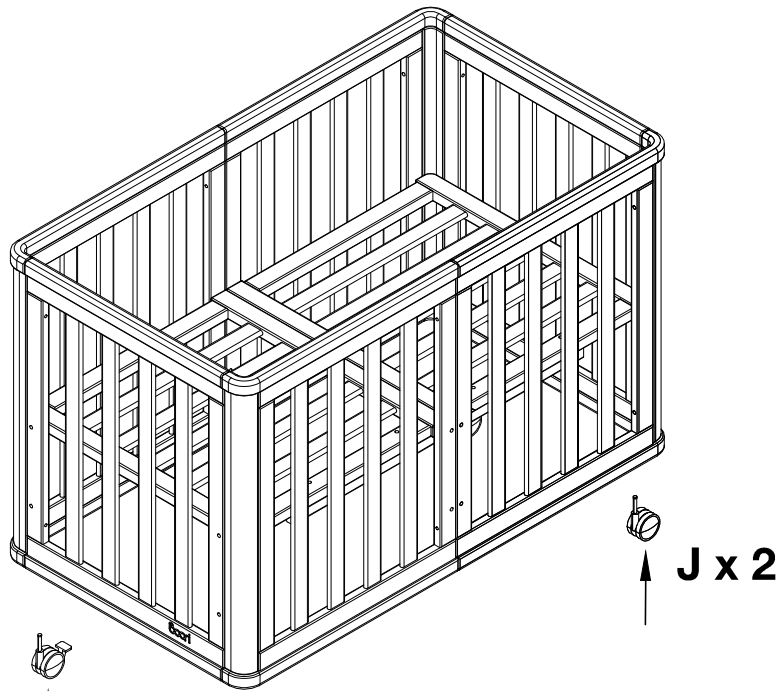

I x 2

J x 2

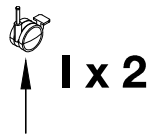
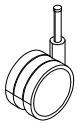
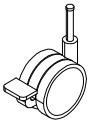

I x 2

6

Please fill in the holes as shown to protect baby from poking fingers into the holes.
注意：请按照图示把剩余的孔堵上，以免宝宝手指插入孔内造成伤害。



F x 8

H x 8



(F+H) x 8

Assembly / 安装说明

7

Base should be in the low position before child is able to sit up.
当宝宝可以坐起时，请将底板降至低孔位的位置，以防止宝宝爬出护栏。
Loosen the 4 x C and 4 x D connecting bolts in the Fixed Side Panels.
先把固定护栏两端的4颗螺丝C和4颗螺丝D松开一些。

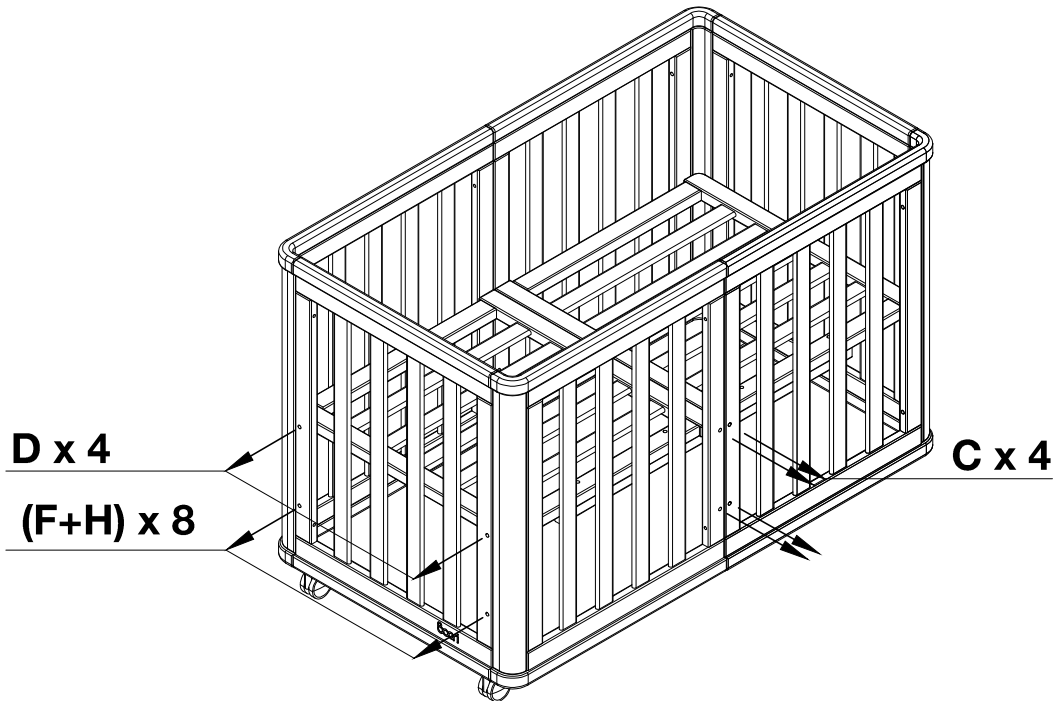

Lowering the base height.
降低床底板。

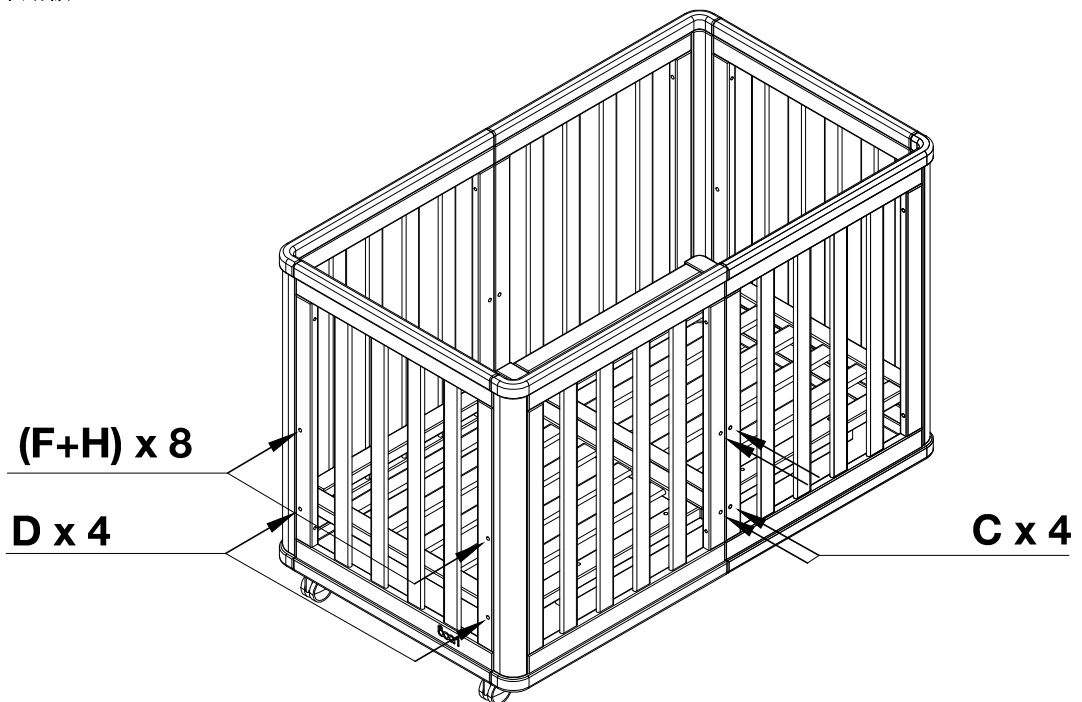

Please fill in the holes as shown to protect baby from poking fingers into the holes.
注意：请按照图示把剩余的孔堵上，以免宝宝手指插入孔内造成伤害。

CONVERT YOUR COT TO TODDLER BED / 转换成儿童床

1

Make sure the base board is in low position.

确保床底板在低孔位。

Please fill in the holes as shown to protect baby from poking fingers into the holes.

注意：请按照图示把剩余的孔堵上，以免宝宝手指插入孔内造成伤害。

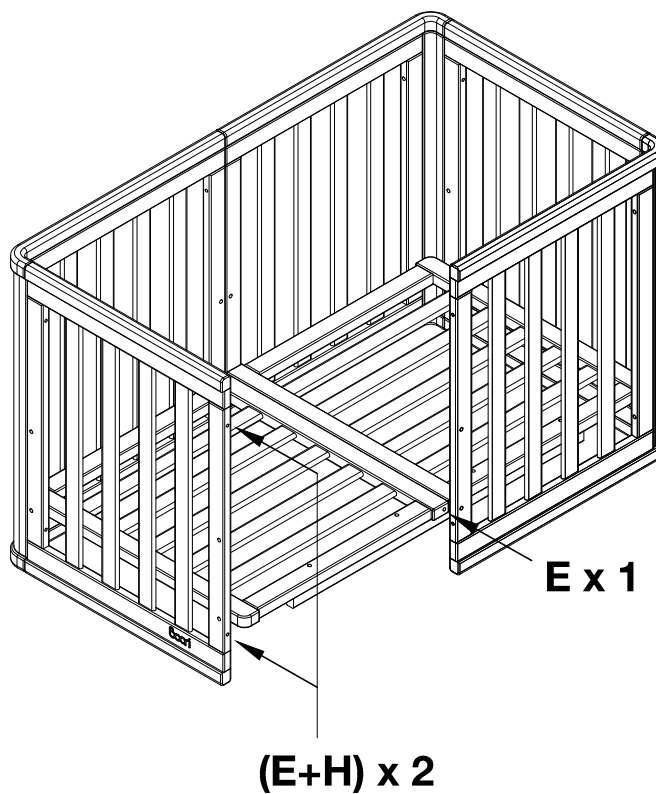
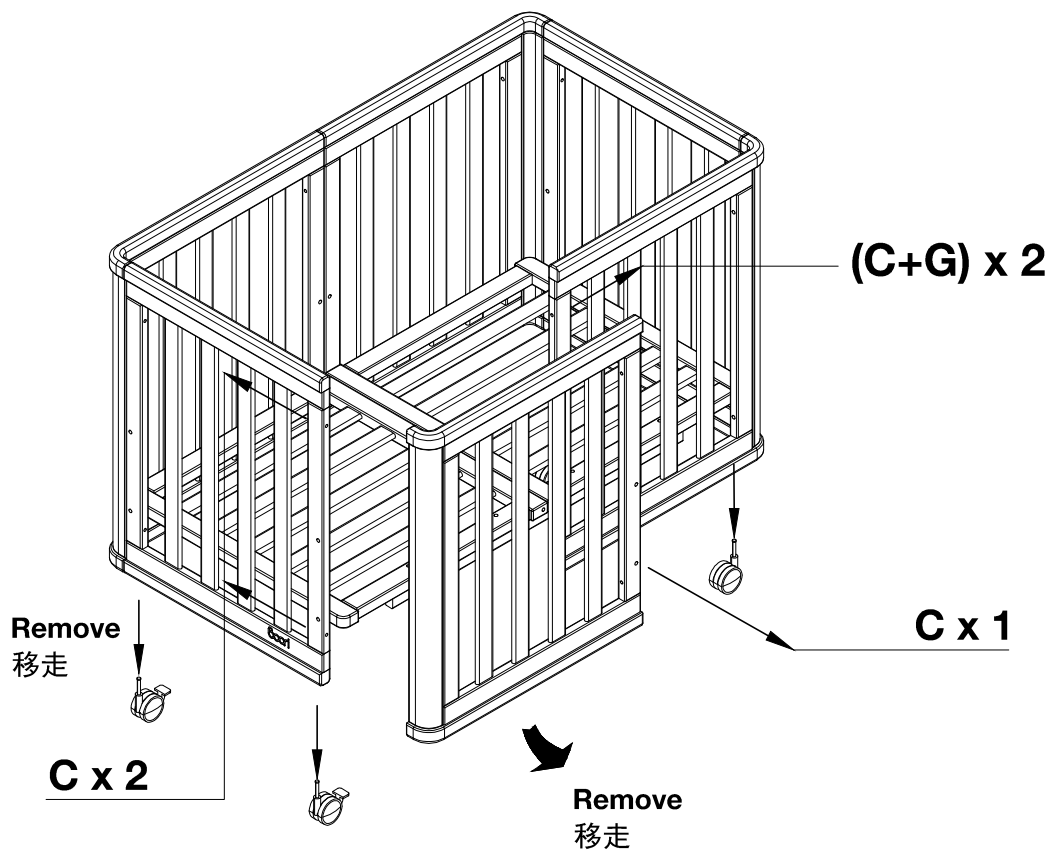

E x 3

H x 2

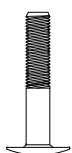

CONVERT YOUR COT TO SOFA CHAIR / 转换成沙发椅

1

Please fill in the holes as shown to protect baby from poking fingers into the holes.
 注意：请按照图示把剩余的孔堵上，以免宝宝手指插入孔内造成伤害。

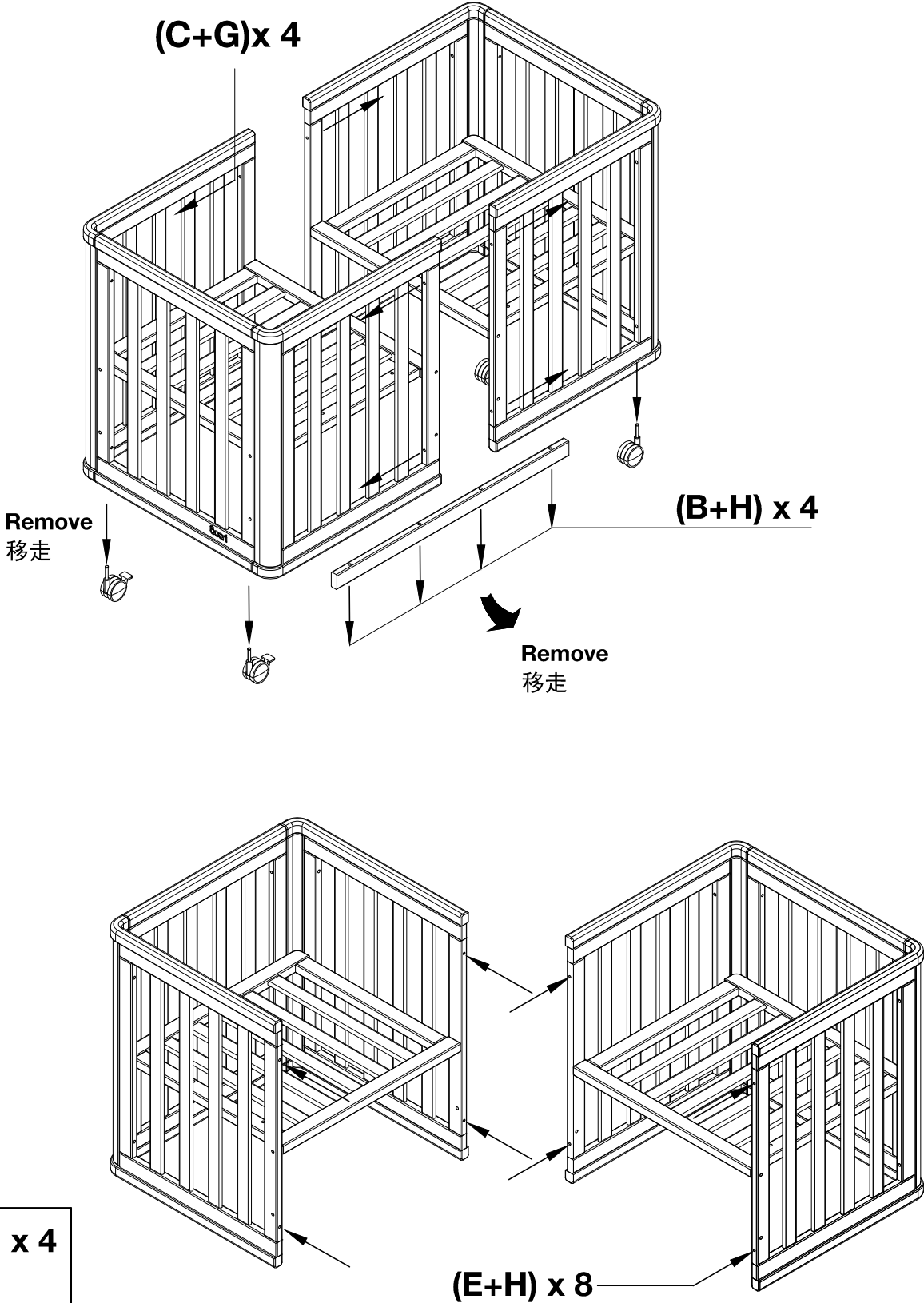

E x 8 H x 4

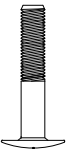

Assembly instructions

NOTE: Use only spare parts approved by the manufacturer

FOR AUSTRALIA AND NEW ZEALAND (AS/NZS 2172:2013)

RECOMMENDED MATTRESS SIZE 1190mm X 650mm X 100mm

This cot has been manufactured for use with a mattress which measures 650mm wide by 1190mm long and 100 mm in thickness. The width and length are specified because it is important that the gaps between the mattress and the sides and ends of the cot will not exceed 40mm when the mattress is pushed to one side or end, and 20 mm when the mattress is centred in the cot. The thickness of the mattress has been specified to ensure that the depth of the cot is greater than 500 mm with the mattress base in the lower position to minimise the risk of a child climbing or falling out of the cot.

WARNING:

*** TO ENSURE THE SAFETY OF YOUR COT, REGULARLY CHECK ALL THE CONNECTING BOLTS AND GLIDE PINS MAKING SURE THEY ARE TIGHT.**

*** TO PREVENT FALLS OR SUFFOCATION THE MAXIMUM MATTRESS THICKNESS SHOULD NOT EXCEED 100MM**

*** WARNING: TO PREVENT FALLS, THE MATTRESS BASE OF THIS COT SHOULD BE ADJUSTED TO THE LOWEST POSITION BEFORE THE CHILD CAN SIT UP.**

* Follow the manufacturer's assembly instructions in detail to ensure the safety features of the cot are not compromised.

* Ensure the cot is placed at a reasonable distance from curtains, blinds, heaters and power points.

* Keep cot free of any toys, cushions etc that could be used as a foothold or present a danger of suffocation or strangulation.

* Keep medication, String, elastic or small items such as money out of reach from any position in the cot.

FOR THE UK (EN 716-1-2 : 2017)

RECOMMENDED MATTRESS SIZE 1190mm X 650mm x 100mm

If you leave the child unattended in the cot, always make sure that the dropside is in the highest position.

This cot has been manufactured for use with a mattress which measures 650mm wide by 1190mm long and a maximum thickness of 100mm. The width and length shall be such that the gap between the mattress and the sides and ends does not exceed 30mm. The thickness of the mattress has been specified to ensure that the depth of the cot is greater than 500mm with the mattress base in the lower position and 200mm with the mattress in the highest position to minimise the risk of a child climbing or falling out of the cot.

WARNING:

*** TO ENSURE THE SAFETY OF YOUR COT, REGULARLY CHECK ALL THE CONNECTING BOLTS AND GLIDE PINS MAKING SURE THEY ARE TIGHT, CARE SHOULD BE TAKEN THAT NO SCREWS ARE LOOSE BECAUSE A CHILD COULD TRAP PARTS OF THE BODY OR CLOTHING (EG. Strings, necklaces, ribbons for babies dummies), WHICH WOULD POSE A RISK OF STRANGULATION.**

*** TO PREVENT FALLS, THE MAXIMUM MATTRESS THICKNESS SHOULD NOT EXCEED 100MM.**

*** THE LOWEST POSITION IS THE SAFEST AND THE BASE SHOULD ALWAYS BE USED IN THAT POSITION AS SOON AS THE BABY IS OLD ENOUGH TO SIT UP.**

*** TO PREVENT INJURY FROM FALLS WHEN THE CHILD IS ABLE TO CLIMB OUT OF THE COT, THE COT SHALL NO LONGER BE USED FOR THAT CHILD.**

* Be aware of the risk of open fire and other sources of strong heat, such as electric bar fires, gas fires, etc. in the near vicinity of the cot.

* Do not use the cot if any part is broken, torn or missing and use only spare parts approved by the manufacturer.

* Do not leave anything in the cot or place the cot close to another product, which could provide a foothold or present a danger of suffocation or strangulation, e.g. strings, blind/curtain cords, etc.

* Do not use more than one mattress in the cot.

* All assembly fittings should always be tightened properly and that fittings should be checked regularly and retightened as necessary.

WARNING: (BS 8509:2008+A1:2011)

* The child's bed conforms to BS 8509:2008 +A1:2011

* Recommended mattress size 1190mm x 650mm x 100mm

* Suitable for a child from 18 months to 4 years old.

* Do not place this child's bed near heat sources, windows and other furniture.

* Do not use this child's bed if any part is broken, torn or missing.

* The bed is designed to be dismantled for storage or transportation.

* All assembly fittings should always be tightened properly and checked periodically.

* Children are likely to play, bounce, jump and climb on beds, therefore the child's bed should not be placed too close to other furniture or windows, blind cords, curtain pulls or other strings or cords, and should be placed either tight to any wall or have a gap of 300mm between the wall and the side of the bed.