

# Boori

## Pioneer

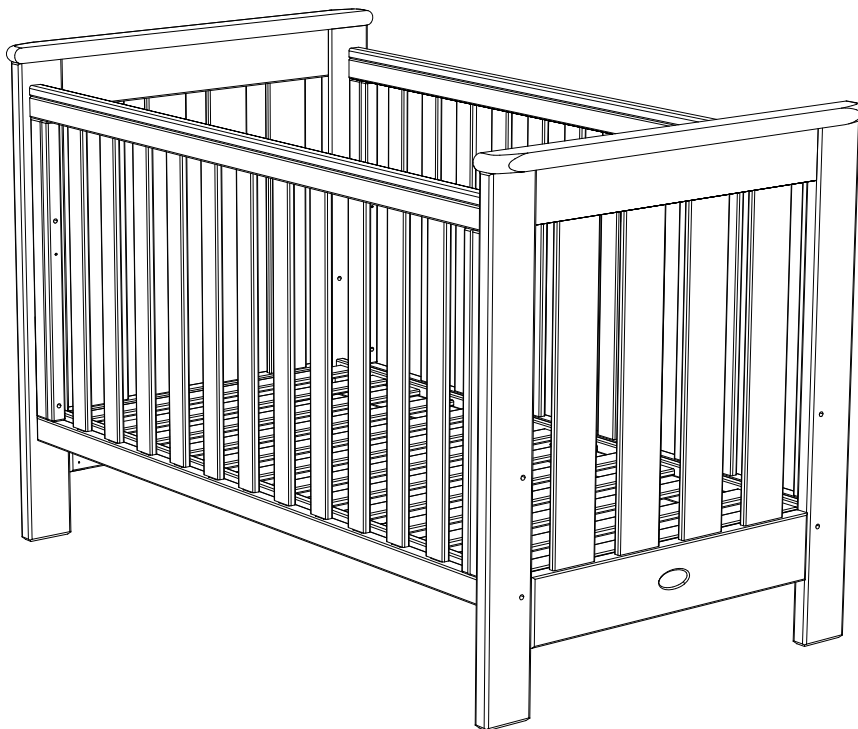

### Cot bed



**IMPORTANT:**  
PLEASE READ THE INSTRUCTIONS CAREFULLY  
AND KEEP FOR FUTURE REFERENCE



**IMPORTANT: THE ASSEMBLY OF THIS PRODUCT REQUIRES TWO PEOPLE  
READ ALL INSTRUCTIONS BEFORE ASSEMBLY AND USE OF THE PRODUCT.**

Boori Australia Pty Ltd  
18-20 Charles Street  
St. Marys Sydney NSW  
2760 Australia  
Ph: 61 2 9833 3769  
Fax: 61 2 9673 4240  
www.boori.com.au

Boori (Europe) Ltd  
Unit 1, Transigo  
Gables Way  
Thatcham, Berkshire,  
RG19 4JZ  
Ph: (44) 016 3529 5670  
Fax: (44) 016 3587 7552  
www.boori.co.uk

Halim & Boori Company  
10F. Halim INT'L B/D, #1674-4,  
Secho-Dong, Seocho-Gu,  
Seoul, Korea  
Tel: +82-2-598-1470  
Fax: +82-2-583-8885  
E-mail : ted@boori.co.kr  
Postal code: 137-725.

ブーリジャパン(株)  
〒541-0057  
大阪府大阪市中央区北久宝寺町  
4-2-10  
Ph : 06-4963-3939  
Fax : 06-4963-3900  
E-mail : info@boori.co.jp

## Instructions for Pioneer Cot bed (B-PICB)

### Hardware and Parts List

2 x Allen Keys

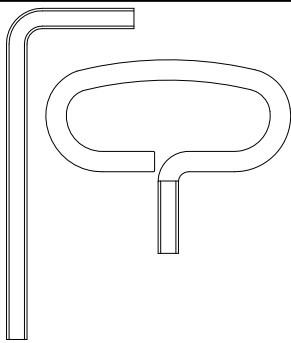

4 x  
Capping  
nuts

**A**

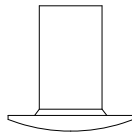

8 x  
23mm  
Connecting  
bolts

**B**

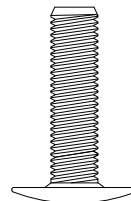

Actual size

12 x  
70mm  
Connecting  
bolts

**C**

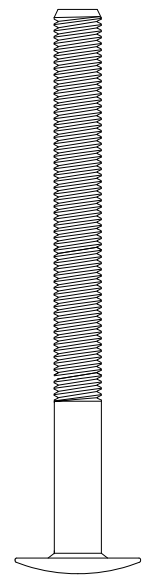

Actual size

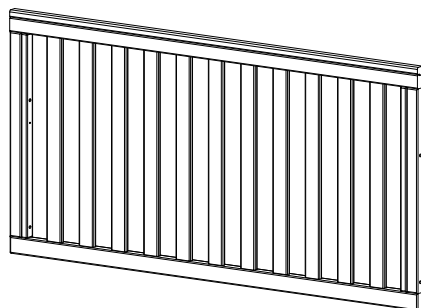

2 x Fixed Side Panels

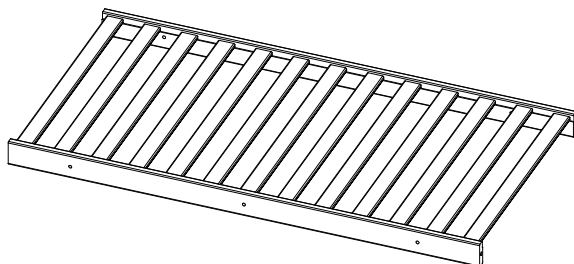

1 x Base

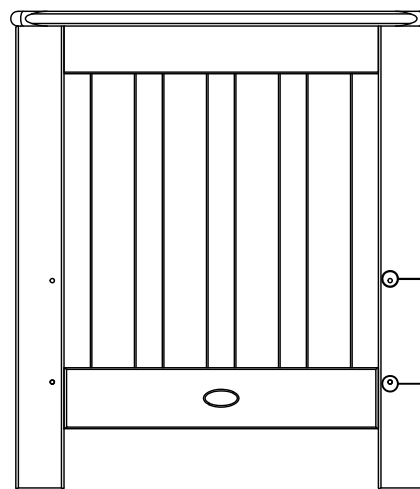

2 x End Panels (Identical)

⊙ **Top Hole**  
high Base position  
(for newborn)

⊙ **Bottom Hole**  
low Base position  
(for baby)

**NOTE:** Use only spare parts approved by the manufacturer.

# ASSEMBLY INSTRUCTIONS

## Step 1: Attach one Fixed Side Panel

Connect one **Fixed Side Panel** to the two **End Panels** with the **4 X C** (70mm) connecting bolts provided.  
(Do not tighten at this step).

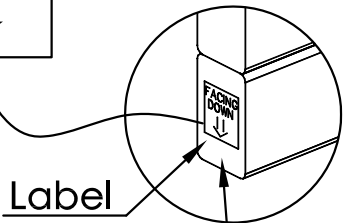
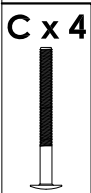

**NOTE: THIS SIDE FACING DOWN WHEN USED AS A COT.**

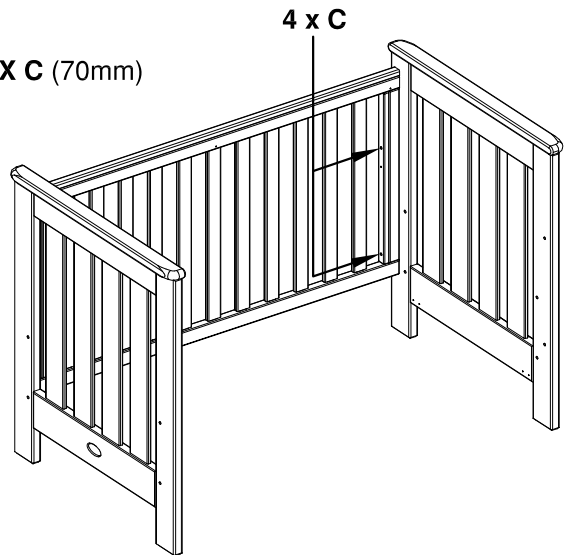

## Step 2: Attach the Base

Connect **Base** to the two **End Panels** with the **4 X C** (70mm) connecting bolts provided.  
(Do not tighten at this step).

**Top Hole** high base position (for newborn).

4 x C

**Bottom Hole** low base position (for baby).

**NOTE:** Base should be lowered to this position before child is able to sit up.

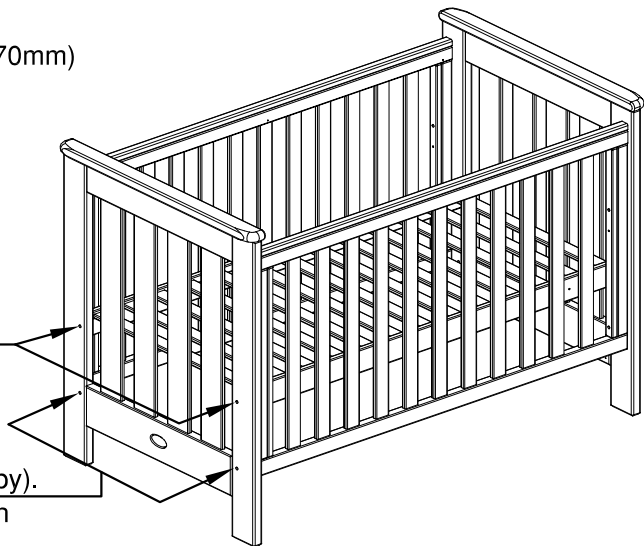
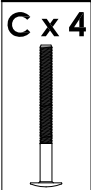

## Step 3: Attach the other Fixed Side Panel

Connect the other **Fixed Side Panel** to the two **End Panels** with the **4 X C** (70mm) connecting bolts provided.

Then cover remaining holes with **4 X B** (23mm) connecting bolts & **4 X A** capping nuts.

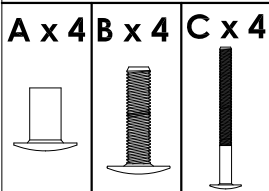

Ver 1.0

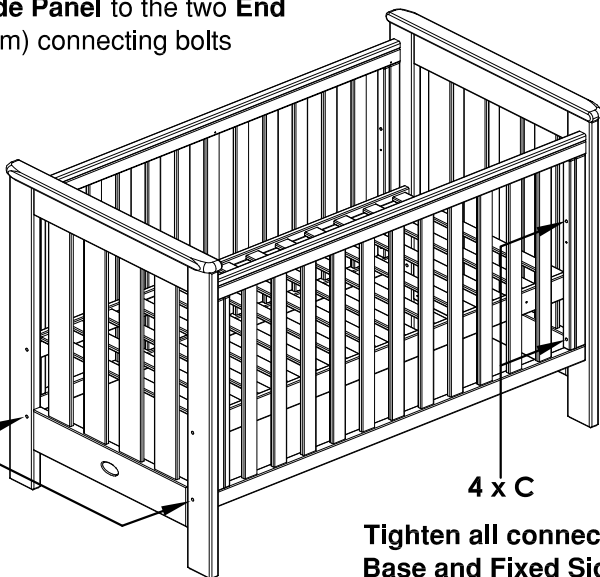

4 x C

**Tighten all connecting bolts in Base and Fixed Side Panels.**

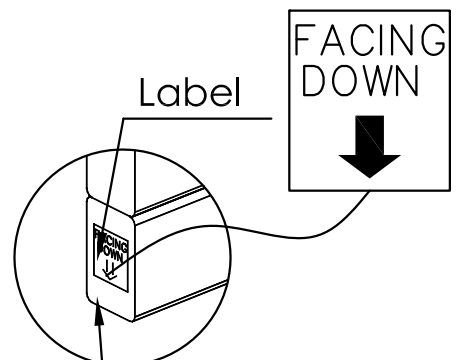

**NOTE: THIS SIDE FACING DOWN WHEN USED AS A COT.**

# ASSEMBLY INSTRUCTIONS

## Step 4: Lower the **Base** height

**A:** Remove **4 X B** connecting bolts & **4 X A** capping nuts from bottom holes in **End Panels**.

**B:** Loosen **8 X C** connecting bolts in **Fixed Side Panels**. Then remove **4 X C** connecting bolts in **Base** and lower **Base** to baby position. Screw **4 X C** connecting bolts into **Base's** Bottom Position Holes.

**C:** Screw **4 X B** connecting bolts & **4 X A** capping nuts into **End Panels'** Top Position Holes.

**NOTE:** Tighten all connecting bolts in **Base** and **Fixed Side**.

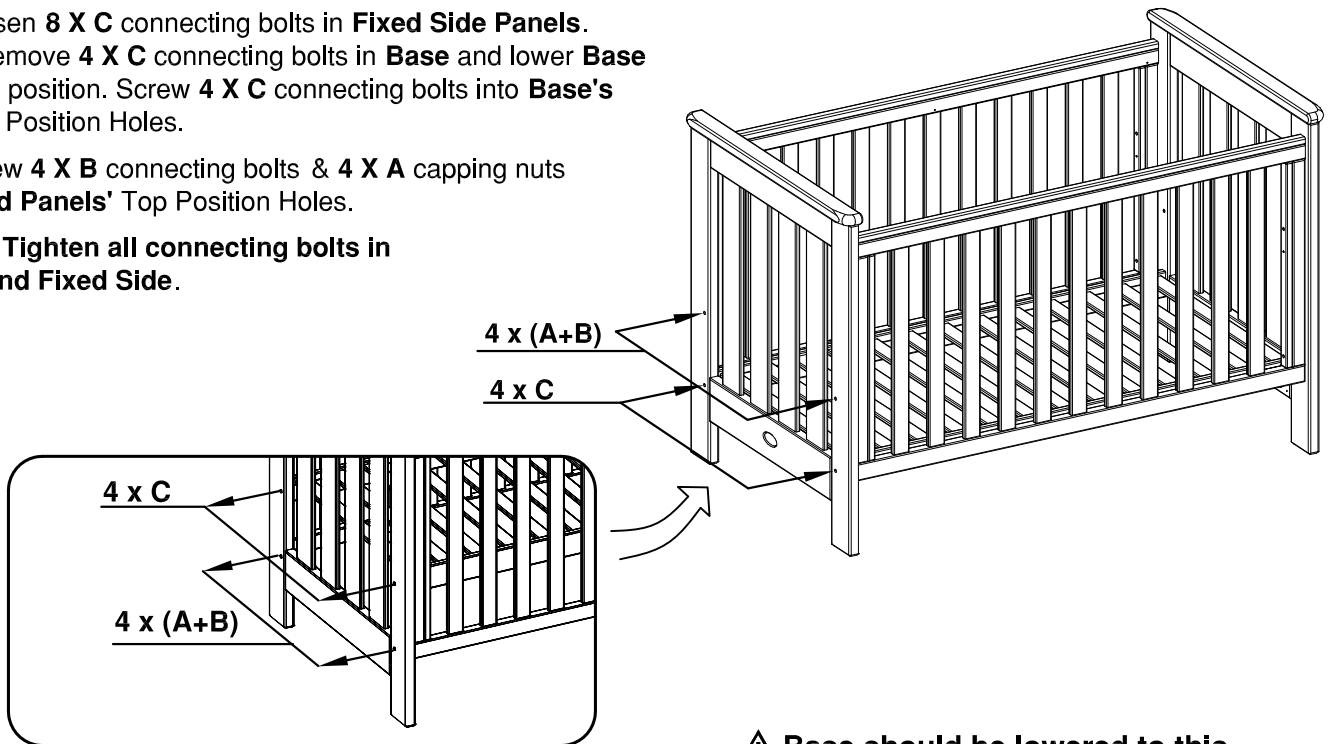

**⚠ Base should be lowered to this position before child is able to sit up.**

## CONVERT YOUR COT TO TODDLER BED

### Step 1:

**A:** Reposition the **Base** to **Bottom Holes'** position.

**B:** Remove **4 X C** in one **Fixed Side Panel**, Loosen **4 X C** in **Base**, then pull **End Panels** apart and remove the **Fixed Side Panel**.

**C:** Remove **4 X C** in the other **Fixed Side Panel**, Turn the **Fixed Side Panel** around and reassemble.

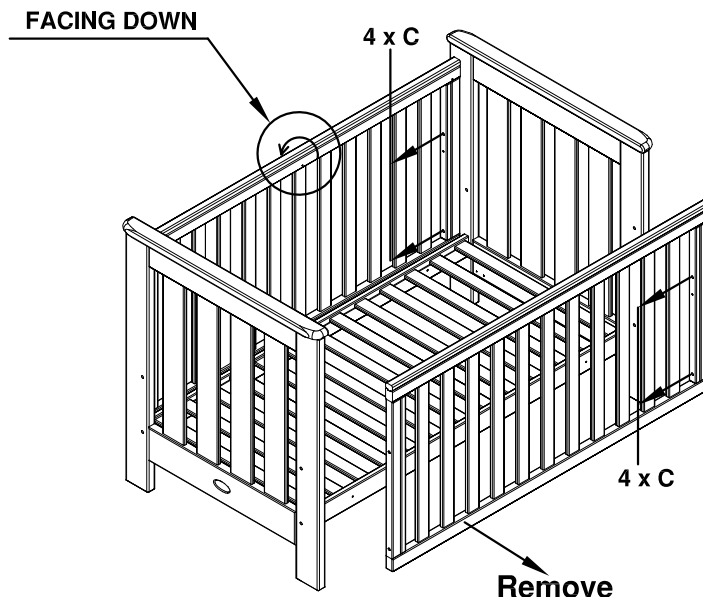

# ASSEMBLY INSTRUCTIONS

## Step 2:

**A:** Connect **Fixed Side Panel** to the two **End Panels** with the **4 X C** connecting bolts.

**B:** Block the remaining holes with **4 X B** connecting bolts, **4 X B** connecting bolts & **4 X A** capping nuts in **End Panels**.

**Tighten all the connecting bolts.**

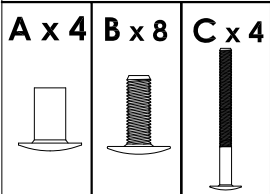
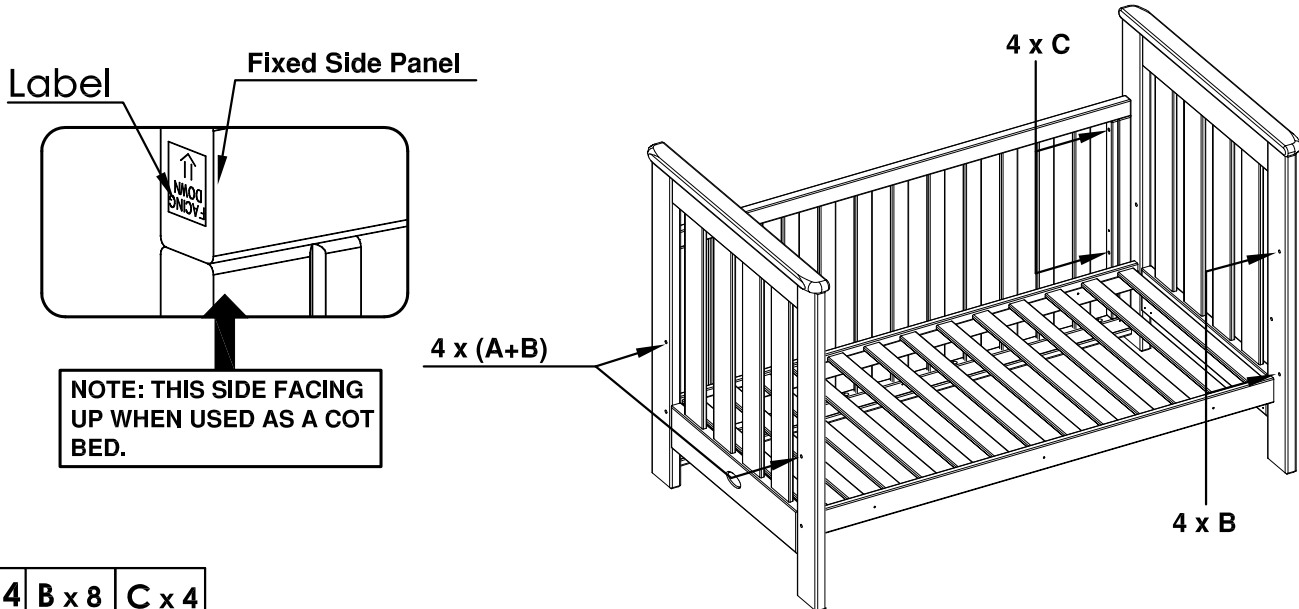

## Step 3:

The Toddler Bed Conversion, item **B-TGP(Universal Toddler Guard Panel)** is sold separately and available in matching finish. Please contact your Boori dealer for more information.

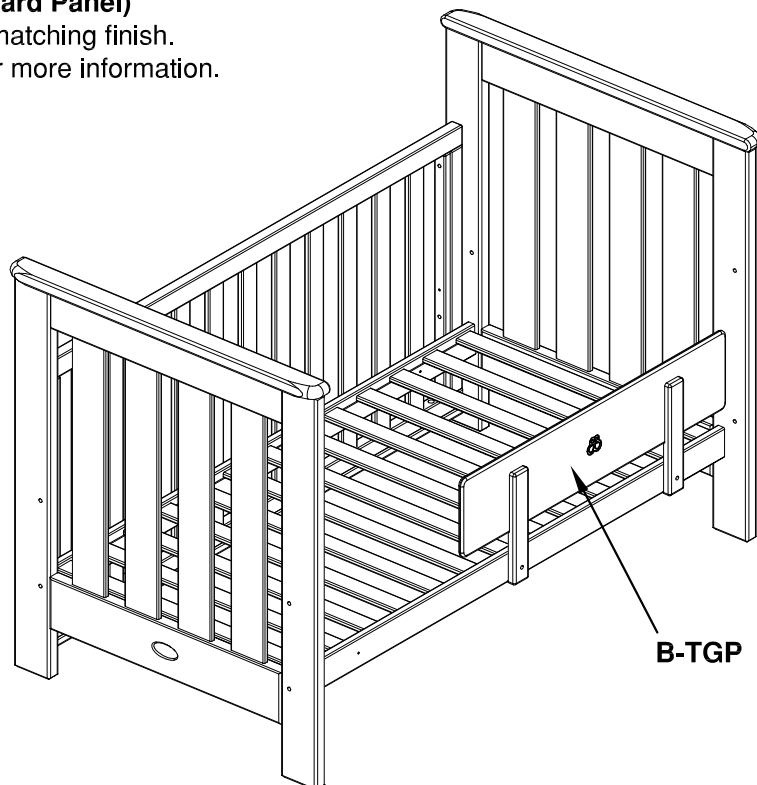

# Assembly instructions

**NOTE:** Use only spare parts approved by the manufacturer

---

## **FOR AUSTRALIA AND NEW ZEALAND (AS/NZS 2172:2013)**

### **RECOMMENDED MATTRESS SIZE 1320mm X 700mm X 120mm**

This cot has been manufactured for use with a mattress which measures 700mm wide by 1320mm long and 120 mm in thickness. The width and length are specified because it is important that the gaps between the mattress and the sides and ends of the cot will not exceed 40mm when the mattress is pushed to one side or end, and 20 mm when the mattress is centred in the cot. The thickness of the mattress has been specified to ensure that the depth of the cot is greater than 500 mm with the mattress base in the lower position to minimise the risk of a child climbing or falling out of the cot.

#### **WARNING:**

**\* TO ENSURE THE SAFETY OF YOUR COT, REGULARLY CHECK ALL THE CONNECTING BOLTS AND GLIDE PINS MAKING SURE THEY ARE TIGHT.**

**\* TO PREVENT FALLS OR SUFFOCATION THE MAXIMUM MATTRESS THICKNESS SHOULD NOT EXCEED 120MM**

**\* WARNING: TO PREVENT FALLS, THE MATTRESS BASE OF THIS COT SHOULD BE ADJUSTED TO THE LOWEST POSITION BEFORE THE CHILD CAN SIT UP.**

\* Follow the manufacturer's assembly instructions in detail to ensure the safety features of the cot are not compromised.

\* Ensure the cot is placed at a reasonable distance from curtains, blinds, heaters and power points.

\* Keep cot free of any toys, cushions etc that could be used as a foothold or present a danger of suffocation or strangulation.

\* Keep medication, String, elastic or small items such as money out of reach from any position in the cot.

---

## **FOR THE UK (EN 716-1-2 : 2017)**

### **RECOMMENDED MATTRESS SIZE 1320mm X 700mm x 120mm**

If you leave the child unattended in the cot, always make sure that the dropside is in the highest position.

This cot has been manufactured for use with a mattress which measures 700mm wide by 1320mm long and a maximum thickness of 120mm. The width and length shall be such that the gap between the mattress and the sides and ends does not exceed 30mm. The thickness of the mattress has been specified to ensure that the depth of the cot is greater than 500mm with the mattress base in the lower position and 200mm with the mattress in the highest position to minimise the risk of a child climbing or falling out of the cot.

#### **WARNING:**

**\* TO ENSURE THE SAFETY OF YOUR COT, REGULARLY CHECK ALL THE CONNECTING BOLTS AND GLIDE PINS MAKING SURE THEY ARE TIGHT, CARE SHOULD BE TAKEN THAT NO SCREWS ARE LOOSE BECAUSE A CHILD COULD TRAP PARTS OF THE BODY OR CLOTHING (EG. Strings, necklaces, ribbons for babies dummies), WHICH WOULD POSE A RISK OF STRANGULATION.**

**\* TO PREVENT FALLS, THE MAXIMUM MATTRESS THICKNESS SHOULD NOT EXCEED 120MM.**

**\* THE LOWEST POSITION IS THE SAFEST AND THE BASE SHOULD ALWAYS BE USED IN THAT POSITION AS SOON AS THE BABY IS OLD ENOUGH TO SIT UP.**

**\* TO PREVENT INJURY FROM FALLS WHEN THE CHILD IS ABLE TO CLIMB OUT OF THE COT, THE COT SHALL NO LONGER BE USED FOR THAT CHILD.**

\* Be aware of the risk of open fire and other sources of strong heat, such as electric bar fires, gas fires, etc. in the near vicinity of the cot.

\* Do not use the cot if any part is broken, torn or missing and use only spare parts approved by the manufacturer.

\* Do not leave anything in the cot or place the cot close to another product, which could provide a foothold or present a danger of suffocation or strangulation, e.g. strings, blind/curtain cords, etc.

\* Do not use more than one mattress in the cot.

\* All assembly fittings should always be tightened properly and that fittings should be checked regularly and retightened as necessary.

---

#### **WARNING: (BS 8509:2008+A1:2011)**

\* The child's bed conforms to BS 8509:2008 +A1:2011

\* Recommended mattress size 1320mm x 700mm x 120mm

\* Suitable for a child from 18 months to 4 years old.

\* Do not place this child's bed near heat sources, windows and other furniture.

\* Do not use this child's bed if any part is broken, torn or missing.

\* The bed is designed to be dismantled for storage or transportation.

\* All assembly fittings should always be tightened properly and checked periodically.

\* Children are likely to play, bounce, jump and climb on beds, therefore the child's bed should not be placed too close to other furniture or windows, blind cords, curtain pulls or other strings or cords, and should be placed either tight to any wall or have a gap of 300mm between the wall and the side of the bed.