

Boori

Classic Royale



Cot bed



**IMPORTANT:
PLEASE READ THE INSTRUCTIONS CAREFULLY
AND KEEP FOR FUTURE REFERENCE**



**IMPORTANT: THE ASSEMBLY OF THIS PRODUCT REQUIRES TWO PEOPLE
READ ALL INSTRUCTIONS BEFORE ASSEMBLY AND USE OF THE PRODUCT.**

Boori Australia Pty Ltd
18-20 Charles Street
St. Marys Sydney NSW
2760 Australia
Ph: 61 2 9833 3769
Fax: 61 2 9673 4240
www.boori.com.au

Boori (Europe) Ltd
Unit 1, Transigo
Gables Way
Thatcham, Berkshire,
RG19 4JZ
Ph: (44) 016 3529 5670
Fax: (44) 016 3587 7552
www.boori.co.uk

Halim & Boori Company
10F. Halim INT'L B/D, #1674-4,
Seocho-Dong, Seocho-Gu,
Seoul, Korea
Tel: +82-2-598-1470
Fax: +82-2-583-8885
E-mail : ted@boori.co.kr
Postal code: 137-725.

ブーリジャパン(株)
〒541-0057
大阪府大阪市中央区北久宝寺町
4-2-10
Ph : 06-4963-3939
Fax : 06-4963-3900
E-mail : info@boori.co.jp

Instructions for Classic Royale Cot bed (B-CLRCB)

Hardware and Parts List

2 x Allen Keys	4 x Capping nuts	4 x 18mm Connecting bolts	4 x 40mm Connecting bolts	12 x 70mm Connecting bolts
	A 	B 	C 	D
		Actual size	Actual size	Actual size

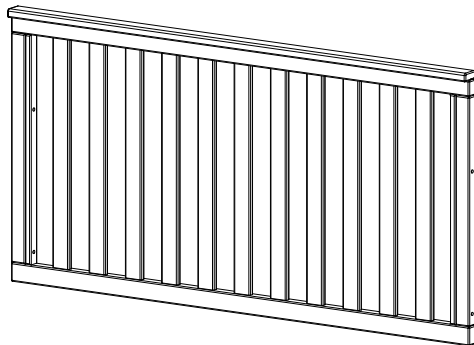

2 x Fixed Side Panels

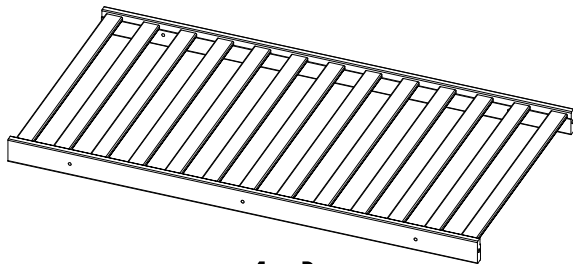

1 x Base

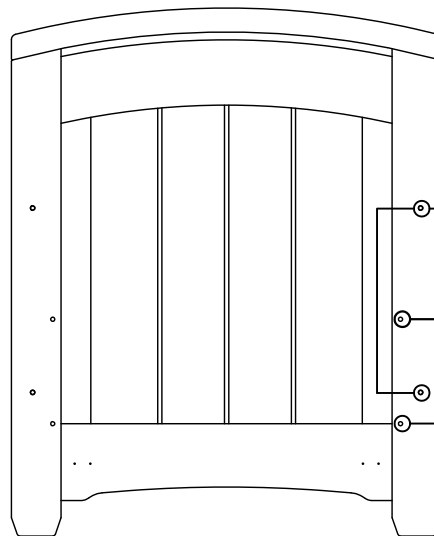

2 x End Panels (Identical)

○ Connecting Bolts Holes

○ Top Hole
high Base position
(for newborn)

○ Bottom Hole
low Base position
(for baby)

NOTE: Use only spare parts approved by the manufacturer.

ASSEMBLY INSTRUCTIONS

Step 1: Attach one Fixed Side Panel

Connect one **Fixed Side Panel** to the two **End Panels** with the **4 X D** (70mm) connecting bolts provided.
(Do not tighten at this step).

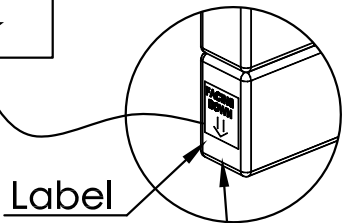
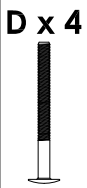

NOTE: THIS SIDE FACING DOWN WHEN USED AS A COT.

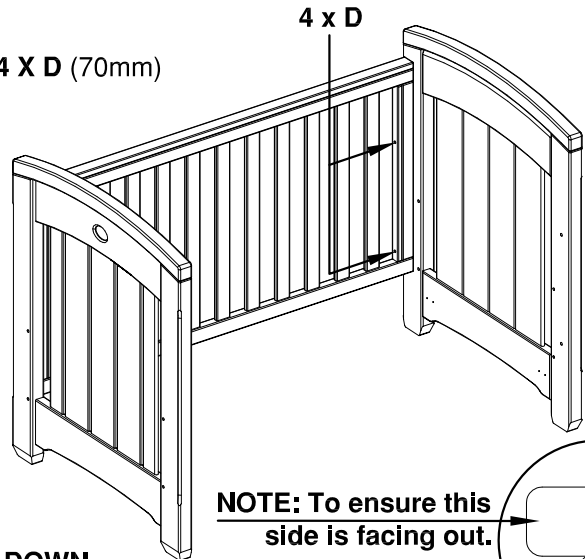

NOTE: To ensure this side is facing out.

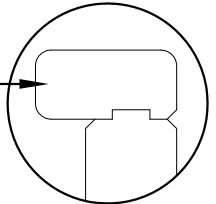

Step 2: Attach the Base

Connect **Base** to the two **End Panels** with the **4 X D** (70mm) connecting bolts provided.
(Do not tighten at this step).

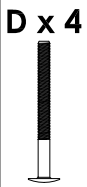

Top Hole high base position (for newborn).

4 x D

Bottom Hole low base position (for baby).

NOTE: Base should be lowered to this position before child is able to sit up.

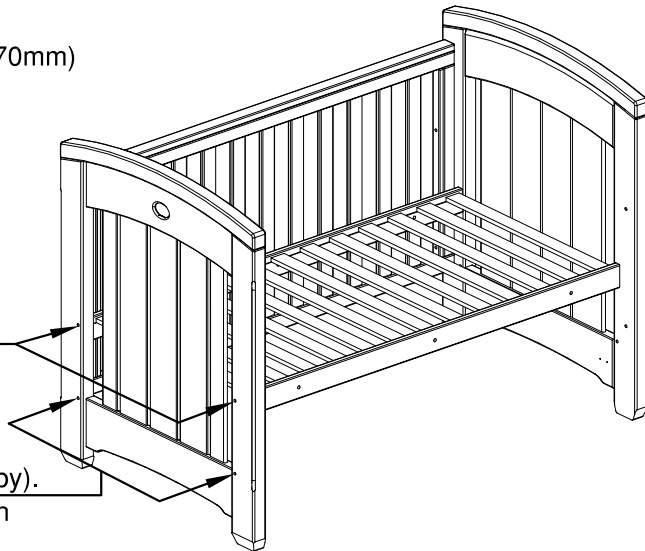

Step 3: Attach the other Fixed Side Panel

Connect the other **Fixed Side Panel** to the two **End Panels** with the **4 X D** (70mm) connecting bolts provided.

Then cover remaining holes with **4 X C** (40mm) connecting bolts & **4 X A** capping nuts.

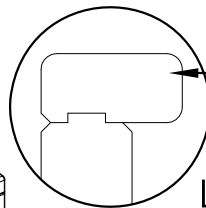
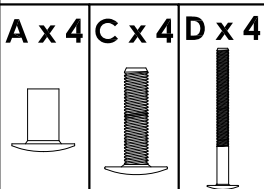

NOTE: To ensure this side is facing out.

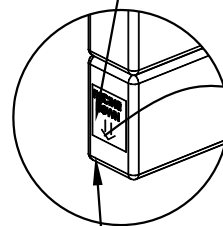

NOTE: THIS SIDE FACING DOWN WHEN USED AS A COT.

4 x D

Tighten all connecting bolts in Base and Fixed Side Panels.

ASSEMBLY INSTRUCTIONS

Step 4: Lower the Base height

A: Remove 4 X C connecting bolts & 4 X A capping nuts from bottom holes in **End Panels**.

B: Loosen 8 X D connecting bolts in **Fixed Side Panels**. Then remove 4 X D connecting bolts in **Base** and lower **Base** to baby position. Screw 4 X D connecting bolts into **Base's** Bottom Position Holes.

C: Screw 4 X C connecting bolts & 4 X A capping nuts into **End Panels'** Top Position Holes.

NOTE: Tighten all connecting bolts in **Base** and **Fixed Side**.

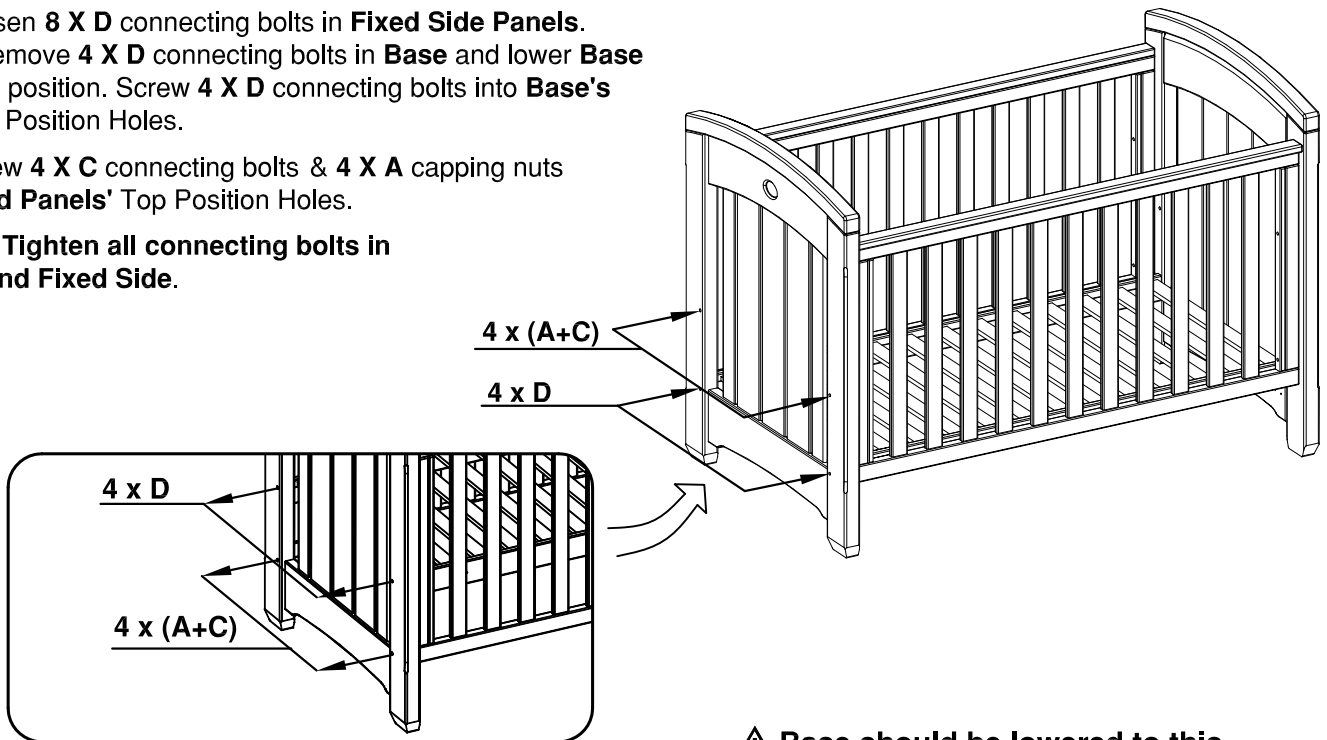

⚠ Base should be lowered to this position before child is able to sit up.

CONVERT YOUR COT TO TODDLER BED

Step 1:

A: Reposition the Base to **Bottom Holes'** position.

B: Remove 4 X D in one **Fixed Side Panel**, Loosen 4 X D in **Base**, then pull **End Panels** apart and remove the **Fixed Side Panel**.

C: Remove 4 X D in the other **Fixed Side Panel**, Turn the **Fixed Side Panel** around and reassemble.

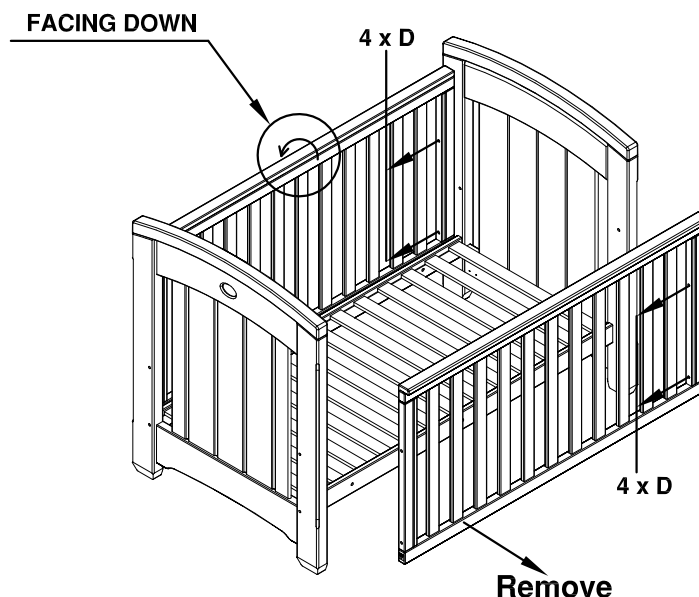

ASSEMBLY INSTRUCTIONS

Step 2:

A: Connect **Fixed Side Panel** to the two **End Panels** with the **4 X D** connecting bolts.

B: Block the remaining holes with **4 X B** connecting bolts, **4 X C** connecting bolts & **4 X A** capping nuts in **End Panels**.

Tighten all the connecting bolts.

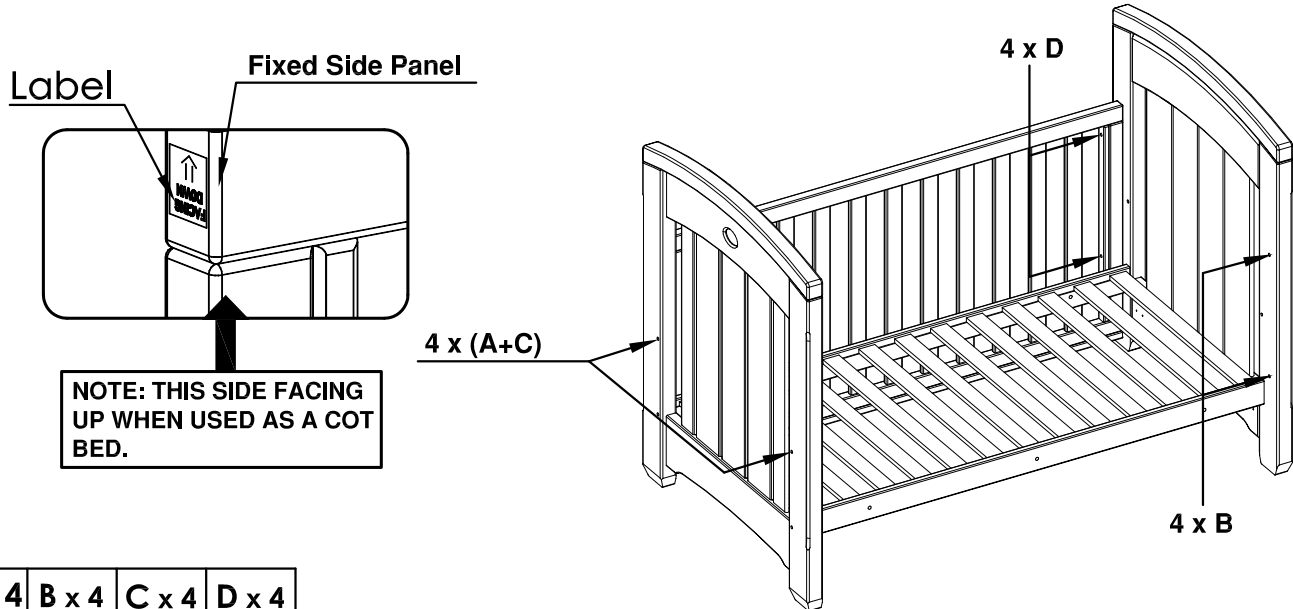

Step 3:

For the Toddler Conversion, item **B-TGP(Universal Toddler Guard Panel)** is included in matching finish.

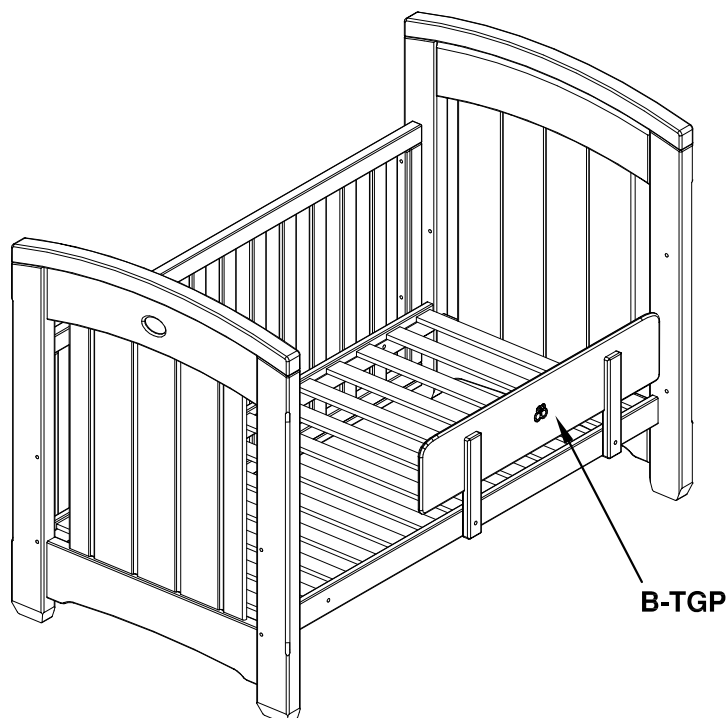

Assembly instructions

NOTE: Use only spare parts approved by the manufacturer

FOR AUSTRALIA AND NEW ZEALAND

(AS/NZS 2172:2013)

RECOMMENDED MATTRESS SIZE 1320mm X 700mm X 120mm

This cot has been manufactured for use with a mattress which measures 700mm wide by 1320mm long and a maximum thickness of 120mm. The width and length are specified because it is important that the gaps between the mattress sides and ends of the cot will not exceed 40mm. This is to minimise the risk of a child's limb becoming caught in the gap. The thickness of the mattress has been specified to ensure that the depth of the cot is greater than 500mm with the mattress base in the lower position to minimise the risk of a child climbing or falling out of the cot.

Warning:

- * **TO ENSURE THE SAFETY OF YOUR COT, REGULARLY CHECK ALL THE CONNECTING BOLTS AND GLIDE PINS MAKING SURE THEY ARE TIGHT.**
- * **TO PREVENT FALLS OR SUFFOCATION THE MAXIMUM MATTRESS THICKNESS SHOULD NOT EXCEED 120MM.**
- * **TO PREVENT FALLS, THE MATTRESS BASE OF THIS COT SHOULD BE ADJUSTED TO THE LOWEST POSITION BEFORE THE CHILD CAN SIT UP.**
- * Follow the manufacturer's assembly instructions in detail to ensure the safety features of the cot are not compromised.
- * Ensure the cot is placed at a reasonable distance from curtains, blinds, heaters and power points.
- * Keep cot free of any toys, cushions etc that could be used as a foothold or present a danger of suffocation or strangulation.
- * Keep medication, String, elastic or small items such as money out of reach from any position in the cot.

FOR THE UK

(EN 716:2008+A1:2013)

RECOMMENDED MATTRESS SIZE 1320mm X 700mm X 120mm

If you leave the child unattended in the cot, always make sure that the dropside is in the highest position.

This cot has been manufactured for use with a mattress which measures 700mm wide by 1320mm long and a maximum thickness of 120mm. The width and length shall be such that the gap between the mattress and the sides and ends does not exceed 30mm. The thickness of the mattress has been specified to ensure that the depth of the cot is greater than 500mm with the mattress base in the lower position and 200mm with the mattress in the highest position to minimise the risk of a child climbing or falling out of the cot.

Warning:

- * **TO ENSURE THE SAFETY OF YOUR COT , REGULARLY CHECK ALL THE CONNECTING BOLTS AND GLIDE PINS MAKING SURE THEY ARE TIGHT, CARE SHOULD BE TAKEN THAT NO SCREWS ARE LOOSE BECAUSE A CHILD COULD TRAP PARTS OF THE BODY OR CLOTHING (EG. Strings, necklaces, ribbons for babies dummies), WHICH WOULD POSE A RISK OF STRANGULATION.**
- * **TO PREVENT FALLS, THE MAXIMUM MATTRESS THICKNESS SHOULD NOT EXCEED 120MM.**
- * **TO PREVENT FALLS, THE MATTRESS BASE OF THIS COT SHOULD BE ADJUSTED TO THE LOWEST POSITION BEFORE THE CHILD CAN SIT UP.**
- * **TO PREVENT INJURY FROM FALLS THAT WHEN THE CHILD IS ABLE TO CLIMB OUT OF THE COT, THE COT SHALL NO LONGER BE USED FOR THAT CHILD.**
- * Be aware of the risk of open fire and other sources of strong heat, such as electric bar fires, gas fires, etc. in the near vicinity of the cot.
- * Do not use the cot if any part is broken, torn or missing and use only spare parts approved by the manufacturer.
- * Do not leave anything in the cot or place the cot close to another product, which could provide a foothold or present a danger of suffocation or strangulation, e.g. strings, blind/curtain cords, etc.
- * Do not use more than one mattress in the cot.

Warning:

(BS 8509:2008+A1:2011)

- * The child's bed conforms to BS 8509:2008 +A1:2011
- * Recommended mattress size 1320mm x 700mm x 120mm
- * Cot bed is Suitable for a child from 18months to 4years old.
- * Do not place this child's bed near heat sources, windows and other furniture.
- * Do not use this child's bed if any part is broken, torn or missing and use only spare parts approved by BOORI AUSTRALIA PTY LTD.
- * The bed is designed to be dismantled for storage or transportation;
- * All assembly fittings should always be tightened properly and checked periodically;
- * Children are likely to play, bounce, jump and climb on beds, therefore the child's bed should not be placed too close to other furniture or windows, blind cords, curtain pulls or other strings or cords, and should be placed either tight to any wall or have a gap of 300mm between the wall and the side of the bed.