

# Boori

## Classic

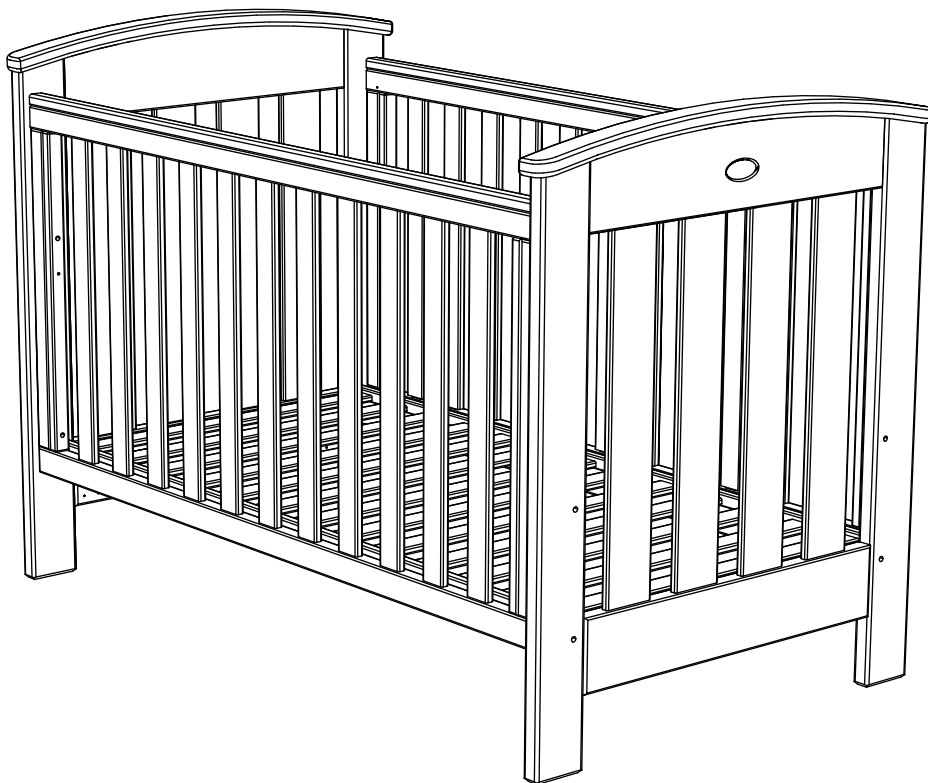

## Cot bed



**IMPORTANT:  
PLEASE READ THE INSTRUCTIONS CAREFULLY  
AND KEEP FOR FUTURE REFERENCE**



**IMPORTANT: THE ASSEMBLY OF THIS PRODUCT REQUIRES TWO PEOPLE  
READ ALL INSTRUCTIONS BEFORE ASSEMBLY AND USE OF THE PRODUCT.**

**Boori Australia Pty Ltd**  
26 Peter Brock Drive  
Eastern Creek Sydney  
NSW 2766 Australia  
Tel: +61 2 9833 3769  
Fax: +61 2 9673 4240  
www.boori.com.au

**Boori (Europe) Ltd**  
Unit 1 Riverside House,  
Mill Lane, Newbury,  
Berkshire, RG 14 5QS UK  
Tel: +44 016 3529 5670  
Fax: +44 016 3587 7552  
www.boori.co.uk

**Halim & Boori Company**  
10F. Halim INT'L B/D, #1674-4,  
Seocho-Dong, Seocho-Gu,  
Seoul, Korea  
Tel: +82 2598 1470  
Fax: +82 2583 8885  
E-mail : ted@boori.co.kr  
Postal code: 137-725.

フーリシャパン株式会社  
〒141-0031  
東京都品川区西五反田  
7-22-17 TOCビル5F  
TEL:03-6420-0024  
EMAIL:info@boori.co.jp  
HP:www.boori.jp

上海微奈沙商贸有限公司  
博瑞儿童用品(上海)有限公司  
上海市盈港东路6433号1幢B区101室  
邮编: 201703  
电话: +86 21 5296 6600  
传真: +86 21 5296 6636  
网址: www.boori.com.cn

## Instructions for Classic Cot bed Version 2 (B-CLCBDv2)

### Hardware and Parts List

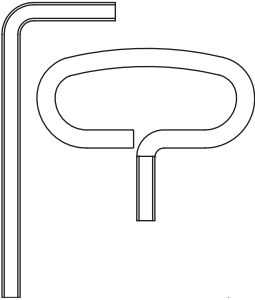
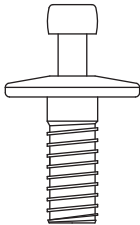
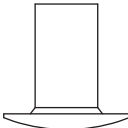
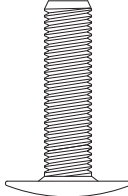
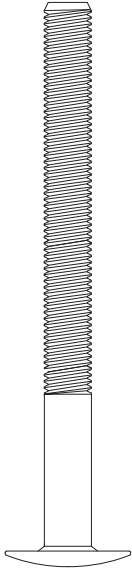
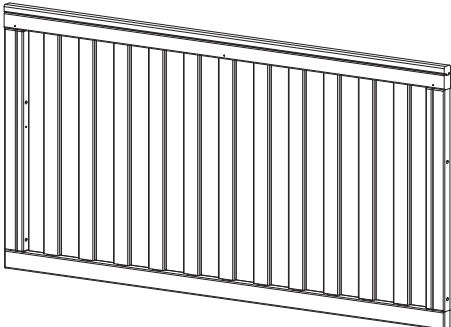
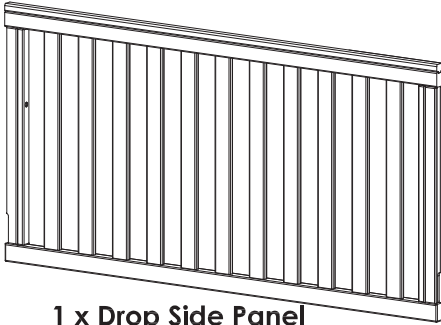
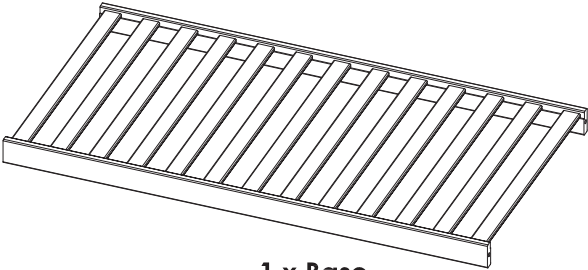
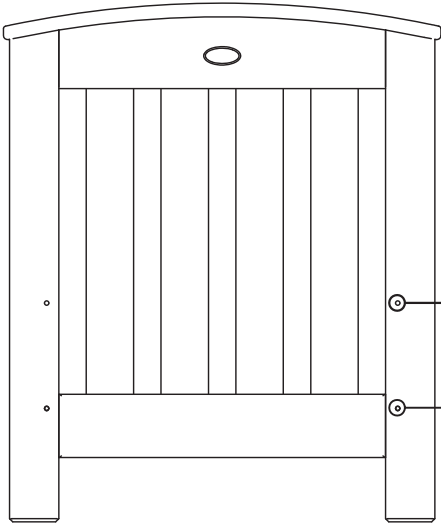
2 x Allen Keys	4 x Drop side glide pins	4 x Capping nuts	4 x 23mm Connecting bolts	8 x 70mm Connecting bolts
	<p><b>A</b></p> 	<p><b>B</b></p> 	<p><b>C</b></p> 	<p><b>D</b></p> 
		Actual size	Actual size	
 <p><b>1 x Fixed Side Panel</b></p>		 <p><b>1 x Drop Side Panel</b></p>		<p>Actual size</p>
 <p><b>1 x Base</b></p>		 <p><b>2 x End Panels (Identical)</b></p> <p>4</p> <p>Top Hole high Base position (for newborn)</p> <p>Bottom Hole low Base position (for baby)</p>		

**NOTE:** Use only spare parts approved by the manufacturer.

# ASSEMBLY INSTRUCTIONS

## Step 1: Attach the Fixed Side Panel

**A:** Connect the **Fixed Side Panel** to the two **End Panels** with the **4 X D** (70mm) connecting bolts provided.  
(Do not tighten at this step).

**B:** Screw **4 X A** drop side glide pins firmly into the **End Panels** using a philips head screwdriver.  
(not supplied)

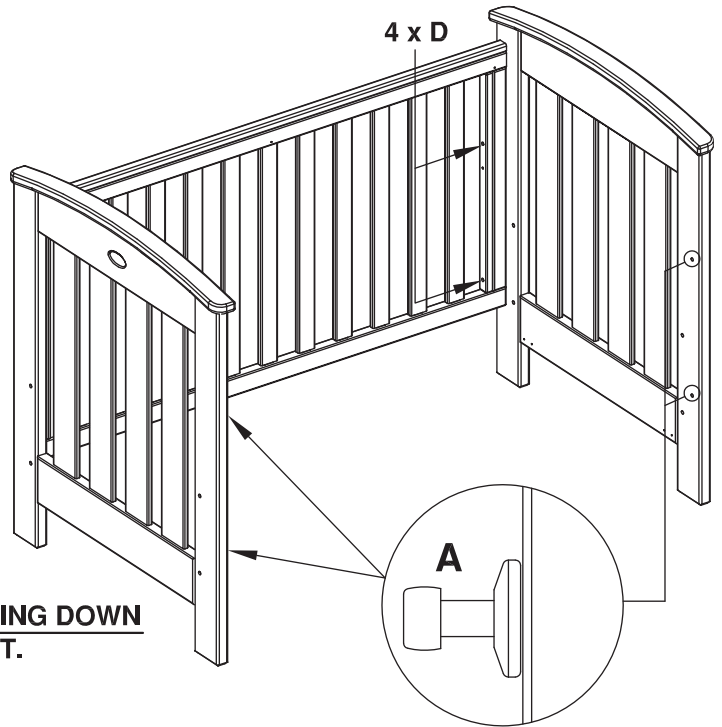
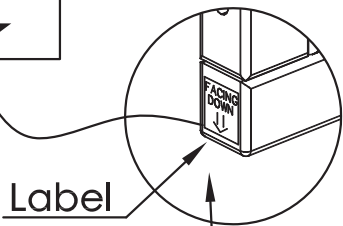

**NOTE: THIS SIDE FACING DOWN WHEN USED AS A COT.**

**A x 4 D x 4**



## Step 2: Attach the Base

Connect **Base** to the two **End Panels** with the **4 X D** (70mm) connecting bolts provided.  
(Do not tighten at this step).

**Top Hole** high base position (for newborn).

**4 x D**

**Bottom Hole** low base position (for baby).



Base should be lowered to this position before child is able to sit up.

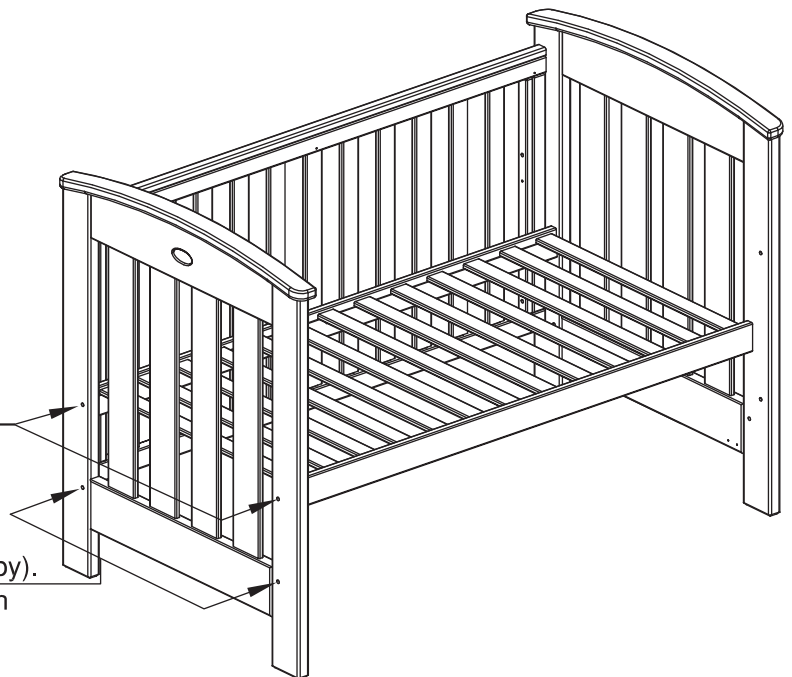

**D x 4**



# ASSEMBLY INSTRUCTIONS

## Step 3: Attach the Drop Side Panel

Then cover remaining holes with **4 X C** (23mm) connecting bolts & **4 X B** capping nuts.

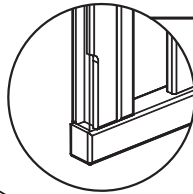

**Ensure that correct side is facing out**

**A:** Push **End Panels** outward to allow space for the assembly of the **Drop Side**. Allow glide pins of one **End Panel** to attach into the runner on **Drop Side** first, then allow the pins on the other side to slide into runner and pull both **End Panels** inward.

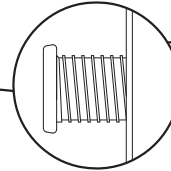

**B:** Fully screw in blocking bolts on both end bars of **Drop Side**.

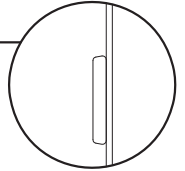

**C:** Tighten all connecting bolts in **Base and Fixed Side**.



Label

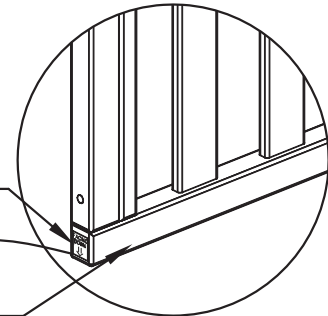

**NOTE: THIS SIDE FACING DOWN WHEN USED AS A COT.**

**B x 4 C x 4**

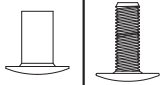

**TO LOWER THE DROP SIDE** pull the Drop Side up to the highest position. Hold It In that position while using your leg to push (at the centre bottom bar) inward. Then allow the Drop Side to slide down. **TO RAISE THE DROP SIDE** pull the Drop Side up from the centre of top bar until it clicks into the locking position.

## Step 4: Lower the Base height

**A:** Remove **4 X C** connecting bolts & **4 X B** capping nuts from bottom holes in **End Panels**.

**B:** Loosen **8 X D** connecting bolts in **Fixed Side Panels**. Then remove **4 X D** connecting bolts in **Base** and lower **Base** to baby position. Screw **4 X D** connecting bolts into **Base's** Bottom Position Holes.

**C:** Screw **4 X C** connecting bolts & **4 X B** capping nuts into **End Panels'** Top Position Holes.

**NOTE:** Tighten all connecting bolts in **Base and Fixed Side**.

4 x (B+C)

4 x D

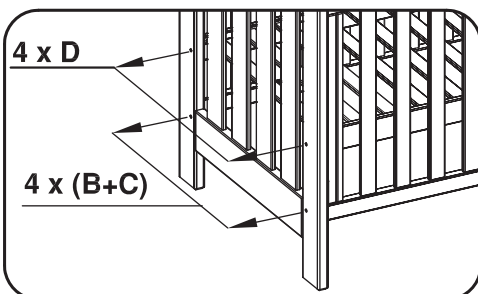

**Base should be lowered to this position before child is able to sit up.**

## How to use the Drop Side

### Step 5:

To lower the Drop Side follow steps 1-3 as shown below.

To raise the Drop Side, raise the Drop Side to its highest position and then release.

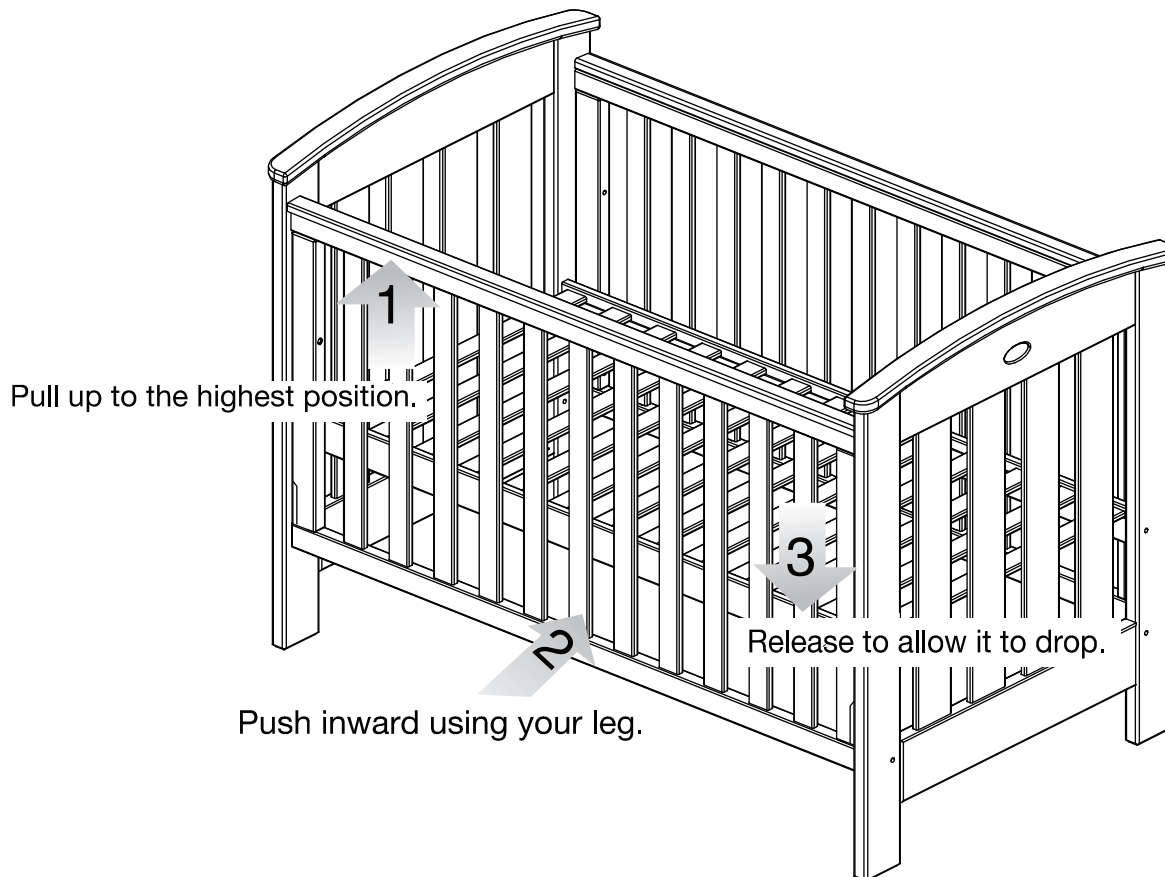

**⚠** If your child is not supervised, ensure the drop side panel is raised for safety.

# Assembly instructions

**NOTE:** Use only spare parts approved by the manufacturer

---

## **FOR AUSTRALIA AND NEW ZEALAND (AS/NZS 2172:2013)**

### **RECOMMENDED MATTRESS SIZE 1320mm X 700mm X 120mm**

This cot has been manufactured for use with a mattress which measures 700mm wide by 1320mm long and 120 mm in thickness. The width and length are specified because it is important that the gaps between the mattress and the sides and ends of the cot will not exceed 40mm when the mattress is pushed to one side or end, and 20 mm when the mattress is centred in the cot. The thickness of the mattress has been specified to ensure that the depth of the cot is greater than 500 mm with the mattress base in the lower position to minimise the risk of a child climbing or falling out of the cot.

#### **WARNING:**

**\* TO ENSURE THE SAFETY OF YOUR COT, REGULARLY CHECK ALL THE CONNECTING BOLTS AND GLIDE PINS MAKING SURE THEY ARE TIGHT.**

**\* TO PREVENT FALLS OR SUFFOCATION THE MAXIMUM MATTRESS THICKNESS SHOULD NOT EXCEED 120MM**

**\* WARNING: TO PREVENT FALLS, THE MATTRESS BASE OF THIS COT SHOULD BE ADJUSTED TO THE LOWEST POSITION BEFORE THE CHILD CAN SIT UP.**

\* Follow the manufacturer's assembly instructions in detail to ensure the safety features of the cot are not compromised.

\* Ensure the cot is placed at a reasonable distance from curtains, blinds, heaters and power points.

\* Keep cot free of any toys, cushions etc that could be used as a foothold or present a danger of suffocation or strangulation.

\* Keep medication, String, elastic or small items such as money out of reach from any position in the cot.

---

## **FOR THE UK (EN 716-1-2 : 2017)**

### **RECOMMENDED MATTRESS SIZE 1320mm X 700mm x 120mm**

If you leave the child unattended in the cot, always make sure that the dropside is in the highest position.

This cot has been manufactured for use with a mattress which measures 700mm wide by 1320mm long and a maximum thickness of 120mm. The width and length shall be such that the gap between the mattress and the sides and ends does not exceed 30mm. The thickness of the mattress has been specified to ensure that the depth of the cot is greater than 500mm with the mattress base in the lower position and 200mm with the mattress in the highest position to minimise the risk of a child climbing or falling out of the cot.

#### **WARNING:**

**\* TO ENSURE THE SAFETY OF YOUR COT, REGULARLY CHECK ALL THE CONNECTING BOLTS AND GLIDE PINS MAKING SURE THEY ARE TIGHT, CARE SHOULD BE TAKEN THAT NO SCREWS ARE LOOSE BECAUSE A CHILD COULD TRAP PARTS OF THE BODY OR CLOTHING (EG. Strings, necklaces, ribbons for babies dummies), WHICH WOULD POSE A RISK OF STRANGULATION.**

**\* TO PREVENT FALLS, THE MAXIMUM MATTRESS THICKNESS SHOULD NOT EXCEED 120MM.**

**\* THE LOWEST POSITION IS THE SAFEST AND THE BASE SHOULD ALWAYS BE USED IN THAT POSITION AS SOON AS THE BABY IS OLD ENOUGH TO SIT UP.**

**\* TO PREVENT INJURY FROM FALLS WHEN THE CHILD IS ABLE TO CLIMB OUT OF THE COT, THE COT SHALL NO LONGER BE USED FOR THAT CHILD.**

\* Be aware of the risk of open fire and other sources of strong heat, such as electric bar fires, gas fires, etc. in the near vicinity of the cot.

\* Do not use the cot if any part is broken, torn or missing and use only spare parts approved by the manufacturer.

\* Do not leave anything in the cot or place the cot close to another product, which could provide a foothold or present a danger of suffocation or strangulation, e.g. strings, blind/curtain cords, etc.

\* Do not use more than one mattress in the cot.

\* All assembly fittings should always be tightened properly and that fittings should be checked regularly and retightened as necessary.

---

#### **WARNING: (BS 8509:2008+A1:2011)**

\* The child's bed conforms to BS 8509:2008 +A1:2011

\* Recommended mattress size 1320mm x 700mm x 120mm

\* Suitable for a child from 18 months to 4 years old.

\* Do not place this child's bed near heat sources, windows and other furniture.

\* Do not use this child's bed if any part is broken, torn or missing.

\* The bed is designed to be dismantled for storage or transportation.

\* All assembly fittings should always be tightened properly and checked periodically.

\* Children are likely to play, bounce, jump and climb on beds, therefore the child's bed should not be placed too close to other furniture or windows, blind cords, curtain pulls or other strings or cords, and should be placed either tight to any wall or have a gap of 300mm between the wall and the side of the bed.



### **Boori Care Instructions**

Congratulations and thank you for choosing Boori product(s). The furniture you have purchased is constructed from high quality materials for strength and durability. Here are some tips on how you can preserve its beauty for a long time.

1. Do not expose furniture to strong sunlight, direct heat sources, extreme changes in temperature or moisture.
2. Wipe up spills immediately with a soft, clean cloth.
3. Urine spills on furniture can cause discolouration.
4. Clean furniture by wiping the surface with a soft cloth dampened with water.
5. If necessary clean furniture using a mild soap solution and wipe clean with a soft cloth dampened with water and then dry with soft clean cloth.
6. Do not use strong household cleaners.
7. Always wipe in the direction of the grain in the wood do not wipe in a circular motion.
8. Avoid contact with sharp objects, or containers containing hot liquid.
9. Avoid contact with 'rubber feet' on items such as radios, computers, telephones etc. Use a felt mat (not plastic) to protect furniture surfaces.
10. Do not open more than one drawer at a time.
11. When moving furniture do not drag always lift and place in position.

### **Boori Warranty**

All Boori products (including mattresses) carry a full five (5) year manufacturer's warranty as testimony to the quality and longevity of the range. This warranty excludes general wear & tear and damage caused, by the product not being used in accordance with its instructions or the care instructions.

During this guarantee period Boori will replace or repair any defective part. In the event of a product being replaced, as a whole unit or part thereof during the guarantee period, the guarantee on the replacement will expire five (5) years from the original purchase date.

This guarantee excludes accidental damage, misuse and or improper transporting and handling.

The warranty is void if the original product has been altered in design or colour in anyway.

**All warranty claims must be lodged at the place of original purchase and proof of purchase must be provided in order to lodge a warranty claim.**



## Warranty against defects



**For Australia only** (updated 01/01/2012)

### **Boori Australia Pty Ltd**

18-20 Charles Street, St.Marys Sydney Nsw 2760 Australia

PH:(61 2) 9833 3769 FAX:(61 2) 9673 4240

ABN: 43 160 962 354

### **Boori Care Instructions**

Congratulations and thank you for choosing Boori product(s). The furniture you have purchased is constructed from high quality materials for strength and durability. Here are some tips on how you can preserve its beauty for a long time.

1. Do not expose furniture to strong sunlight, direct heat sources, extreme changes in temperature or moisture.
2. Wipe up spills immediately with a soft, clean cloth.
3. Urine spills on furniture can cause discolouration.
4. Clean furniture by wiping the surface with a soft cloth dampened with water.
5. If necessary clean furniture using a mild soap solution and wipe clean with a soft cloth dampened with water and then dry with soft clean cloth.
6. Do not use strong household cleaners.
7. Always wipe in the direction of the grain in the wood do not wipe in a circular motion.
8. Avoid contact with sharp objects, or containers containing hot liquid.
9. Avoid contact with 'rubber feet' on items such as radios, computers, telephones etc. Use a felt mat (not plastic) to protect furniture surfaces.
10. Do not open more than one drawer at a time.
11. When moving furniture do not drag, always lift and place in position.

### **Boori Warranty (“this Warranty”)**

All Boori Collection products (“Boori Products”) (including mattresses) carry a full five (5) year manufacturer’s warranty (“Warranty Period”) to the end-purchaser (“the Customer”) as testimony to the quality and longevity of the range. This warranty excludes general wear & tear and damage caused, by the Boori Product not being used in accordance with its instructions or the care instructions. During this Warranty Period Boori Australia Pty Ltd (ABN 43 160 962 354) (“Boori”) will replace or repair any defective part. In the event of a Boori Product being replaced, as a whole unit or part thereof during the Warranty Period, the warranty on the replacement will expire five (5) years from the original purchase date.

This guarantee excludes accidental damage, misuse and or improper transporting and handling.



The warranty is void if the original Boori Product has been altered in design or colour in anyway.

**All warranty claims must be lodged:**

- 1. at the place of original purchase as set out on your receipt for purchase of the Boori Products or you may contact Boori on 9833 3769 to obtain further details;and**
- 2. together with a proof of purchase.**

Where the Customer makes a claim pursuant to this Warranty, all expenses incurred in sending the Boori Products to Boori are the Customer's responsibility.

Boori's liability in respect of a breach of a consumer guarantee or any warranty made under this Warranty for any Boori Products not of a kind ordinarily acquired for personal, domestic or household use is limited, in relation to the Boori Products to the extent permissible by law and at it's option to:

1. replacing the Boori Products or the supply of equivalent Boori Products;
2. the repair of the Boori Products;
3. the payment of the cost of replacing the Boori Products or of acquiring equivalent goods; or
4. the payment of the cost of having the Boori Products repaired.

To the extent permitted by law, all other warranties whether implied or otherwise, not set out in this Warranty are excluded and Boori is not liable in contract, tort (including, without limitation, negligence or breach of statutory duty) or otherwise to compensate the Customer for:

1. any increased costs or expenses;
2. any loss of profit, revenue, business, contracts or anticipated savings;
3. any loss or expense resulting from a claim by a third party; or
4. any special, indirect or consequential loss or damage of any nature whatsoever caused by the Customer's failure in complying with its obligations.

**Limitations on Warranty Disclaimers**

In the following paragraph, 'Our' means 'Boori', 'You' means 'the Customer' and 'goods' means 'Boori Products':

*Our goods come with guarantees that cannot be excluded under the Australian Consumer Law. You are entitled to a replacement or refund for a major failure and for compensation for any other reasonably foreseeable loss or damage. You are also entitled to have the goods repaired or replaced if the goods fail to be of acceptable quality and the failure does not amount to a major failure.*

The benefits given to the Customer in this Warranty are in addition to other rights and remedies under a law in relation to the Boori Products to which this warranty applies.